

Fine filters

Size 0

G 1/8
FV 05 / FM 05 / FA 05

Pre-filter	0.3 µm
Fine filter	0.01 µm

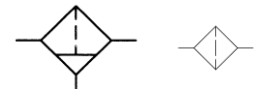

Characteristics

Type	FV 05	FM 05	FA 05
Port	G 1/8		
Type of construction	Pre-filter 0.3 µm	Micro-filter 0.01 µm	Activated carbon filter
Mounting position	Vertical, drain plug at bottom		
Input pressure p ₁	1.5 to 16 bar Max. 10 bar with fully automatic drain		
Dust separation	>0.3 µm / 99.999%	>0.01 µm / 99.999%	
Residual oil content		0.01 mg/m ³	0.005 mg/m ³
Temperature Ambient / medium	-10 to 60 °C (other temperature ranges on request)		
Nominal flow Q _n	130 l/min	230 l/min	310 l/min
Δp*	0.02 bar	0.1 bar	0.2 bar
Bowl capacity	Max. 16 cm ³		
Condensate drain	Semi-automatic (standard) Manual on request		
Mounting type	In-line, bracket kit		
Weight [g]	0.210		

*See overleaf for flow rate equation

Materials

Designation	Material
Head piece	Zinc – Z 410
O-ring 30 x 2	NBR
O-ring 10.8 x 1.2	NBR
Pre-filter element	Paper – POM
Micro-filter element	Borosilicate – POM
Activated carbon element	Activated carbon – POM
Condensate bowl	Polycarbonate
Oil bowl	Polycarbonate

Ordering information

Options	
K(-HA)	Plastic bowl
M	Metal bowl

Order example:

FV 05 K-HA → Pre-filter with plastic bowl and semi-automatic condensate drain valve

Description

- Block design
- Simple block mounting of several devices with conical clamps (**no tools required**)
- Coupler packs (**KP 05**) are required for modular assembly of several devices
→ **p₁ max. = 12 bar**
- Flow direction indicated by arrows
- **Entry in direction of arrow**
- Bowl guard **not possible**

Filter elements

Designation	Part No.
P re-filter element	V 23/35
M icro-filter element	M 23/40
A ctivated carbon element	A 23/60

Dimensions [mm]

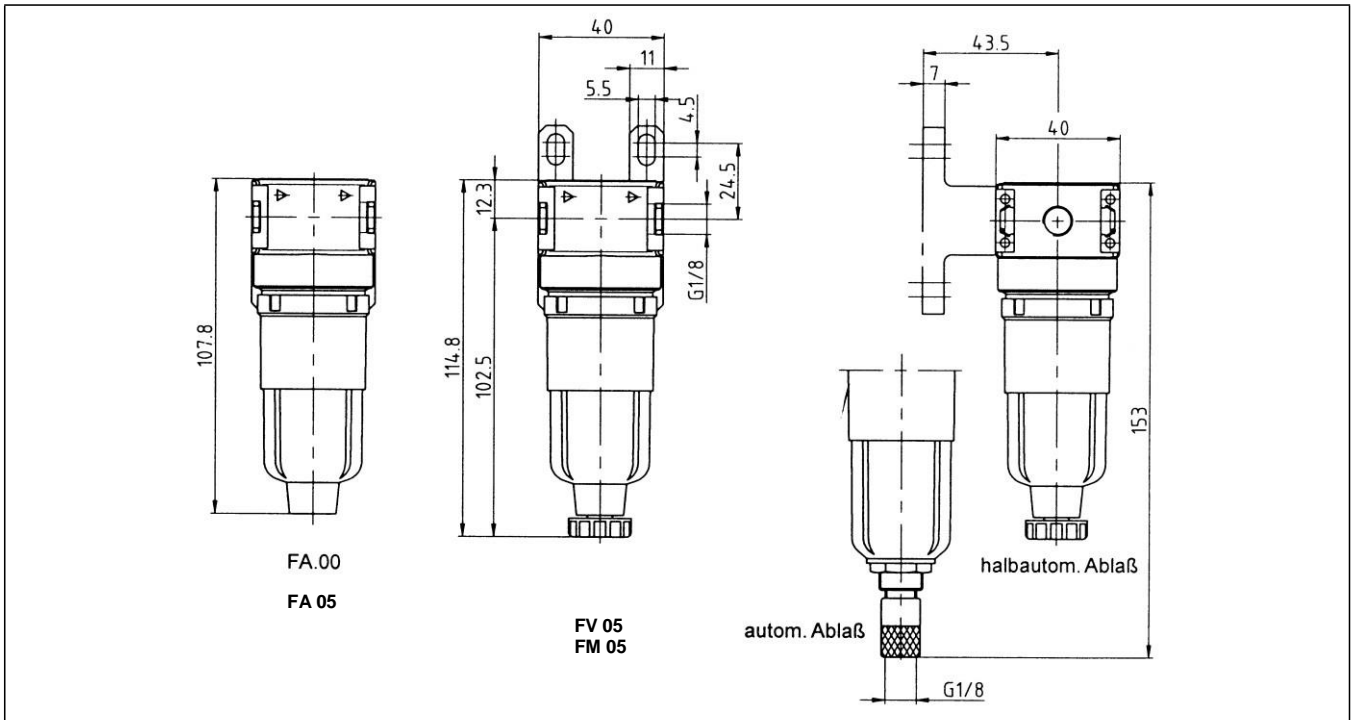

Typical application

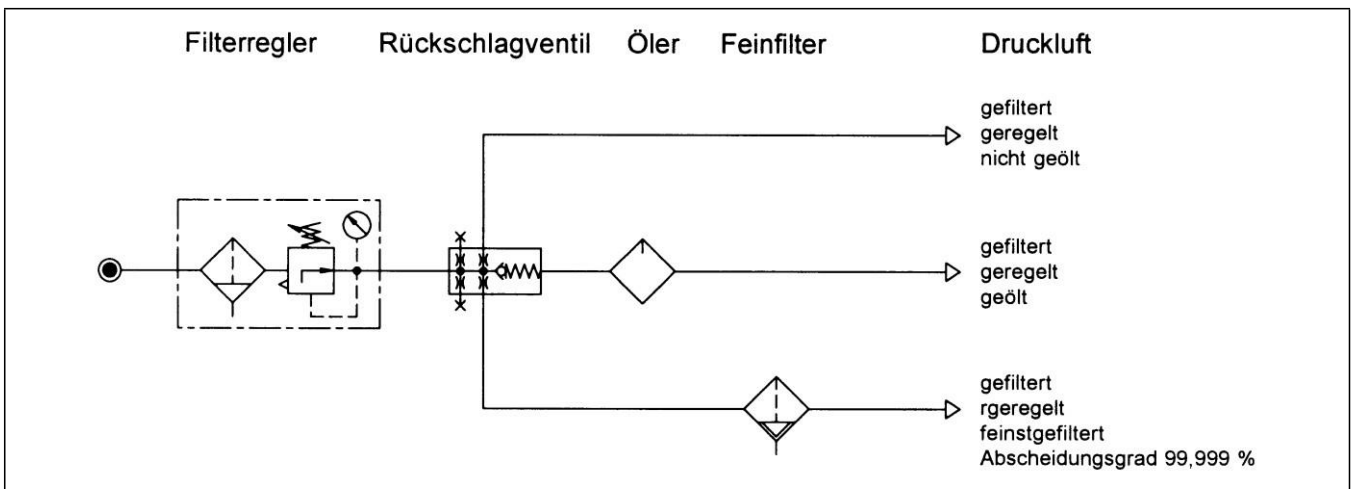

Flow rates

Required flow $Q = \text{nominal flow } Q_n \times \text{correction factor } f \rightarrow Q = Q_n \times f$

p [bar]	1	2	3	4	5	6	7	8	9	10	11	12	13	14	15	16
f	0.46	0.6	0.68	0.77	0.85	0.93	1	1.07	1.11	1.17	1.23	1.28	1.32	1.36	1.4	1.46

Accessories

Designation	Part No.
Bracket kit	ZW 05
Polycarbonate bowl (FV / FM)	640/1
Polycarbonate bowl (FA)	740/01
Coupler pack (max. 12 bar)	KP 05