

5/3-way valve

manually operated

PLUS

Art. No. 106484

Type No. 514.143

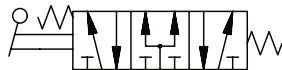

Exemplary illustration

Traditional way valves of series 70 in manually operated version with hand lever. These valves are also suitable for use with vacuum.

Technical data

| | |
|-------------------------|--|
| Operating pressure | Max. vacuum 10 bar |
| Temperature range | -10 to 60 °C |
| Valve body | Aluminium |
| Piston | Nickel-plated aluminium |
| Medium | Filtered compressed air with or without lubrication. If lubricated, then continuous. |
| Sealant | NBR |
| Spring | Special steel |
| Flow rate measurement 1 | Flow rate at 6 bar and Δp 0.5 bar |
| Flow rate 1 | 3200 NI/min |
| Flow rate measurement 2 | Flow rate at 6 bar and Δp 1.0 bar |
| Flow rate 2 | 4600 NI/min |
| Connection | G 1/2 |
| Function | 5/3 |
| Operation | Mid-position pressurised, spring return |
| Symbol | 16 |
| Series | Valves series 70 |

Commercial data

| | |
|-------------------------|------------------|
| Customs tariff number | 84818079 |
| Country of origin | IT |
| eCl@ss 5.1.4 | 27291801 |
| eCl@ss 9.0 | 27291390 |
| UNSPSC_Code_v190501 | 40141603 |
| UNSPSC_CodeDesc_v190501 | Pneumatic valves |

Material informations

| | |
|----------------------------|--------------------|
| REACH SVHC1 substance name | Blei |
| CAS no. SVHC 1 | 7439-92-1 |
| RoHS materials notice | RoHS konform |
| REACH Info | enthält SVHC Stoff |

VALVES SERIES 70

The Series 70 forms part of Metal Work's full range of traditional valves.

They are available in sizes 1/8", 1/4", 3/8" and 1/2", versions 3/2, 5/2, 5/3 and double 3/2, with mechanical, manual, pneumatic and electric drives.

They can be installed in line, onto a wall, on the cylinder (using a special bracket) or in series (on a multiple or modular base) to suit all possible applications.

A range of valves (Series 70 LT) designed using components for specific low-temperature applications is now available for the most commonly used types and sizes.

These highly reliable valves comply with the main applicable standards, including Atex, ISO 13489 and SIL, as stated in the documents and certificates available online.



| TECHNICAL DATA | | 1/8" | 1/4" | 3/8" | 1/2" |
|--|--------------------|--|--------|--------|--------|
| Thread on the valve ports | | 1/8" | 1/4" | 3/8" | 1/2" |
| Operating pressure series 70 versions | bar | 2.5 to 10 | | | |
| monostable and bistable differential | | 1 to 10 | | | |
| bistable | | vacuum to 10 | | | |
| asserved | | | | | |
| Operating pressure series 70 LT (low temperature) versions | bar | vacuum to 10 | | | |
| hand operated | | - | | | |
| pneumatic and solenoid/pneumatic | t = -40°C to -10°C | 5 to 10 | | | |
| | t = -10°C to +60°C | 3 to 10 | | | |
| Minimum pilot pressure | bar | 2.5 | | | |
| Operating temperature range | °C | -10 to +60 | | | |
| series 70 versions | | -40 to +60 | | | |
| series 70 LT (low temperature) versions | | | | | |
| Nominal diameter | mm | 5 | 7.5 | 13.3 | 15 |
| Conductance C | Nl/min · bar | 121.43 | 264.26 | 505.52 | 971.43 |
| Critical ratio b | bar/bar | 0.32 | 0.27 | 0.32 | 0.43 |
| Flow rate at 6 bar ΔP 0.5 bar | Nl/min | 400 | 750 | 1560 | 3200 |
| Flow rate at 6 bar ΔP 1 bar | Nl/min | 550 | 1100 | 2150 | 4600 |
| Installation | | In any position (vertical assembly is not recommended for bistable valves subjected to vibration) | | | |
| Fluid | | Filtered air without lubrication; lubrication, if used, must be continuous. | | | |
| Recommended lubricant | | For series 70 LT (low-temperature) versions, it is recommended to use of perfortemente dried air. ISO and UNI FD 22 | | | |
| Maximum coil nut torque | Nm | For series 70 LT (low-temperature) it is not expected to be used with lubricated air. 1 | | | |
| Compatibility with oils | | See chapter Z1 | | | |

COMPONENTS SERIES 70

- ① VALVE BODY: Aluminium
- ② CONTROL/END CAP: plastic
- ③ SPOOL: chemically nickel-plated aluminium
- ④ DISTANCE PLATES: plastic
- ⑤ GASKETS: NBR
- ⑥ PISTONS: Hostaform®
- ⑦ PISTON GASKET: NBR
- ⑧ FILTER: plastic
- ⑨ SPRINGS: special steel
- ⑩ OPERATOR: Brass pipe - Stainless steel core



COMPONENTS SERIES 70 LT (LOW TEMPERATURE)

- ① ALVE BODY: aluminium
- ② CONTROL/END CAP: aluminium
- ③ SPOOL: chemically nickel-plated aluminium
- ④ DISTANCE PLATES: plastic
- ⑤ GASKETS: HNBR
- ⑥ PISTONS: aluminium
- ⑦ PISTON GASKET: HNBR
- ⑧ FILTER: plastic
- ⑨ SPRINGS: special steel
- ⑩ OPERATOR: brass pipe - Stainless steel core
(version specific for low-temperature applications)



VALVES

VALVES SERIES 70

FLOW CHARTS

VALVES SERIES 70 1/8"

Flow rates



VALVES SERIES 70 1/4"

Flow rates



VALVES SERIES 70 3/8"

Flow rates



VALVES SERIES 70 1/2"

Flow rates



VALVES SERIES 70, HAND OPERATED

VALVES

VALVES SERIES 70, HAND OPERATED

| TECHNICAL DATA | | 1/8" | 1/4" | 1/2" |
|-------------------------------|--------------|--------------|--------|--------|
| Operating pressure range: | | | | |
| • version with direct control | bar | Vacuum to 10 | | |
| • pilot-assisted version | bar | 2.5 to 10 | | |
| Operating temperature range | | | | |
| | °C | -10 to +60 | | |
| Nominal diameter | | | | |
| | mm | 5 | 7.5 | 15 |
| Conductance C | Nl/min · bar | 121.43 | 264.26 | 971.43 |
| Critical ratio b | bar/bar | 0.32 | 0.27 | 0.43 |
| Flow rate at 6 bar ΔP 0.5 bar | Nl/min | 400 | 750 | 3200 |
| Flow rate at 6 bar ΔP 1 bar | Nl/min | 550 | 1100 | 4600 |



SYNOPTIC, SIZES AND VERSIONS

| M A V FAMILY | 2 DIMENSIONS | 3 FUNCTION | P P OPERATORS 14 | S RESETTING (12) | N C FURTHER DETAILS |
|-------------------|----------------------------|--------------------------------------|--|---|---|
| MAV manual valves | 2 1/8" 3 1/4" 4 1/2" | 3 3/2 5 5/2 6 5/3 8 2 x 3/2 | PP drawer VL axial lever LE 90° lever BRE arranged for manual panel actuators | A pneumatic/mechanical springs* S mechanical springs B bistable D differential O stable for 5/3 | NC normally closed NO normally open OO no indication CC closed centres OC open centres PC pressure centres |

*on demand

VALVES SERIES 70, HAND OPERATED, 1/8"

90° LEVER 3/2 1/8"

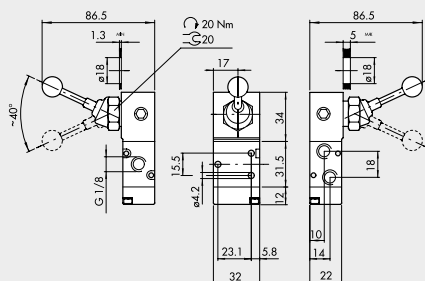

| Symbol | Code | Abbrev. | Weight [g] |
|--------|------------|---------------|------------|
| | 7010000100 | MAV 23 LES NC | 168 |
| | 7010000200 | MAV 23 LEB OO | 171 |

90° LEVER 5/2 1/8"

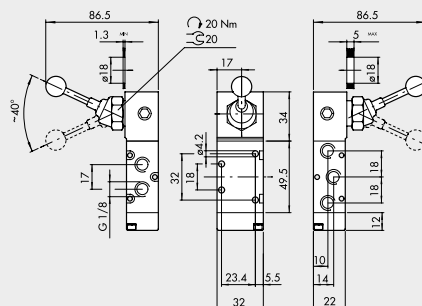

| Symbol | Code | Abbrev. | Weight [g] |
|--------|------------|---------------|------------|
| | 7010000300 | MAV 25 LES OO | 194 |
| | 7010000400 | MAV 25 LEB OO | 197 |

FRONT LEVER 3/2, 1/8"



| Symbol | Code | Abbrev. | Weight [g] |
|--------|------------|---------------|------------|
| | 7010001400 | MAV 23 VLB OO | 130 |

FRONT LEVER 5/2, 1/8"



| Symbol | Code | Abbrev. | Weight [g] |
|--------|------------|---------------|------------|
| | 7010001700 | MAV 25 VLB OO | 156 |

VALVES

VALVES SERIES 70, HAND OPERATED

FRONT LEVER 5/3, 1/8"

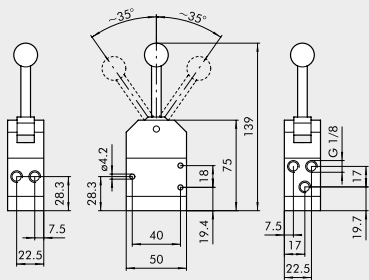

| Symbol | Code | Abbrev. | Weight [g] |
|--------|------------|---------------|------------|
| | 7010001150 | MAV 28 VLO OC | 316 |
| | 7010001160 | MAV 28 VLS OC | 325 |

90° LEVER 5/3, 1/8"



| Symbol | Code | Abbrev. | Weight [g] |
|--------|------------|---------------|------------|
| | 7010001000 | MAV 26 LES CC | 242 |
| | 7010000900 | MAV 26 LES OC | 242 |
| | 7010001100 | MAV 26 LES PC | 242 |
| | 7010000500 | MAV 26 LEO CC | 194 |
| | 7010000600 | MAV 26 LEO OC | 194 |
| | 7010000700 | MAV 26 LEO PC | 194 |



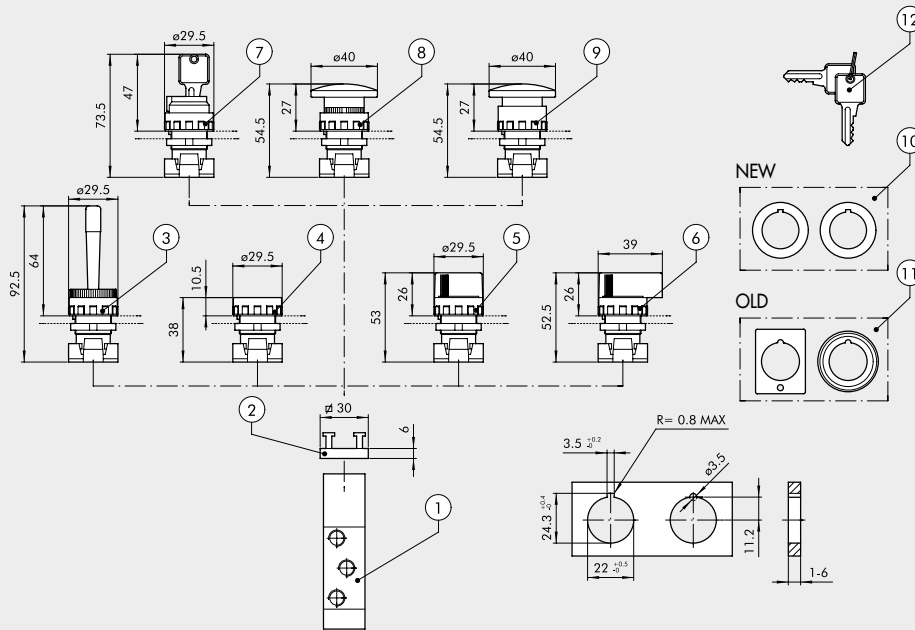













ASSEMBLY DIAGRAM FOR PILOT-ASSISTED HAND-OPERATED VALVES SERIES 70 WITH PANEL ACTUATORS



VALVES

VALVES SERIES 70, HAND OPERATED

ORDERING CODES

| Symbol | Reference | Code | Description | Weight [g] |
|---|-----------|-------------|---|------------|
|  | ① | 7010001800 | Pilot-assisted plunger 3/2, 1/8" | 124 |
|  | ① | 7010001900 | Pilot-assisted plunger 5/2, 1/8" | 150 |
| | ② | 0351000050 | 2 places adaptor thickness 6.8 mm | 5 |
|  | ③ | W0351000015 | Red handler with horizontally pivoted lever | 25 |
|  | ④ | W0351000011 | Fat push button + 2 red/black coloured disks ◆ Bistable fat push button without disk | 15 |
|  | ⑤ | W0351000030 | Black selector short lever at 2 positions with return | 20 |
|  | ⑤ | W0351000031 | Black selector short lever at 2 positions | 20 |
|  | ⑤ | W0351000032 | Black selector short lever at 3 positions with return | 20 |
|  | ⑤ | W0351000033 | Black selector short lever at 3 positions | 20 |
|  | ⑥ | W0351000034 | Black selector long lever at 2 positions with return | 26 |
|  | ⑥ | W0351000035 | Black selector long lever at 2 positions | 26 |
|  | ⑥ | W0351000036 | Black selector long lever at 3 positions with return | 26 |
|  | ⑥ | W0351000037 | Black selector long lever at 3 positions | 26 |
|  | ⑦ | W0351000016 | 2 positions key selector with extractable key in 2 positions | 50 |
|  | ⑦ | W0351000018 | 2 positions key selector with extractable key in 0 | 50 |
|  | ⑧ | W0351000013 | Red mushroom-head push button Ø 40 | 27 |
|  | ⑧ | W0351000017 | Black mushroom-head push button Ø 40 | 27 |
|  | ⑨ | W0351000014 | Red mushroom-head push button with lock Ø 40 | 29 |
| ◆ It can't be supplied. As working replaced by selector with bistable short lever at 2 positions (⑤). | ⑩ | W0351000049 | ◆ Reducer from 30 to 22.5 mm | |
| ♣ Usable only with technopolymer body selectors. | ⑪ | W0351000050 | ♣ Adapter for bore Ø 30 G2326 | |
| ▲ Usable only with metal body selectors. | ⑫ | W0351000021 | ▲ Key for ESC selectors | |
| | | W0351000056 | Green disk for push button (④) | |

VALVES SERIES 70, HAND-OPERATED, 1/4"

VALVES

VALVES SERIES 70, HAND OPERATED

90° LEVER 3/2, 1/4"

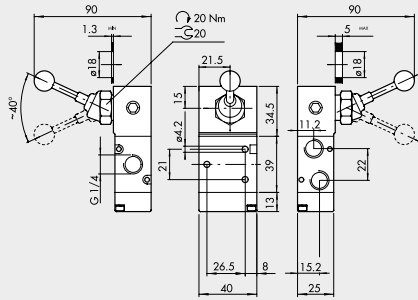

| Symbol | Code | Abbrev. | Weight [g] |
|--------|------------|---------------|------------|
| | 7020000100 | MAV 33 LES NC | 244 |
| | 7020000200 | MAV 33 LEB OO | 244 |

90° LEVER 5/2, 1/4"

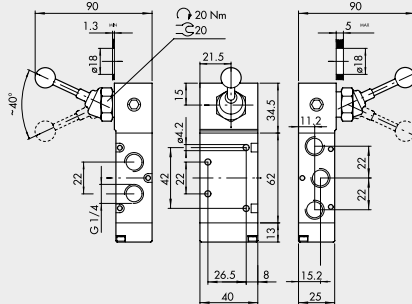

| Symbol | Code | Abbrev. | Weight [g] |
|--------|------------|---------------|------------|
| | 7020000300 | MAV 35 LES OO | 290 |
| | 7020000400 | MAV 35 LEB OO | 290 |

FRONT LEVER 3/2, 1/4"

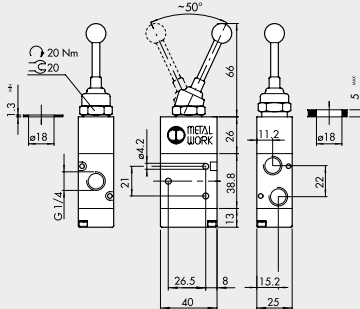

| Symbol | Code | Abbrev. | Weight [g] |
|--------|------------|---------------|------------|
| | 7020001400 | MAV 33 VLB OO | 194 |

FRONT LEVER 5/2, 1/4"

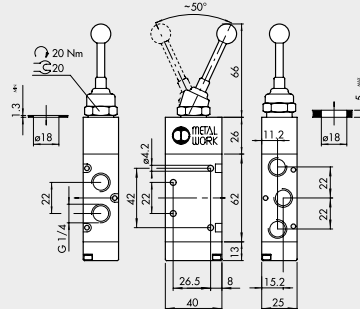

| Symbol | Code | Abbrev. | Weight [g] |
|--------|------------|---------------|------------|
| | 7020001700 | MAV 35 VLB OO | 244 |

90° LEVER 5/3, 1/4"

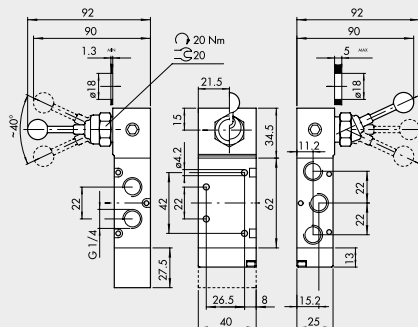

| Symbol | Code | Abbrev. | Weight [g] |
|--------|------------|---------------|------------|
| | 7020001000 | MAV 36 LES CC | 354 |
| | 7020000900 | MAV 36 LES OC | 354 |
| | 7020001100 | MAV 36 LES PC | 354 |
| | 7020000500 | MAV 36 LEO CC | 288 |
| | 7020000600 | MAV 36 LEO OC | 288 |
| | 7020000700 | MAV 36 LEO PC | 288 |

VALVES SERIES 70, HAND OPERATED, 1/2"

90° LEVER 3/2, 1/2"

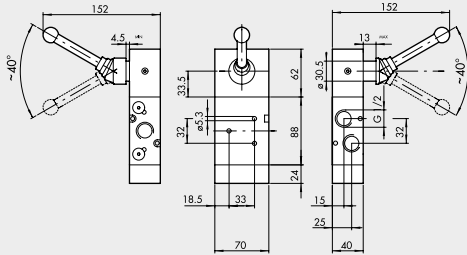

| Symbol | Code | Abbrev. | Weight [g] |
|--------|------------|---------------|------------|
| | 7030000100 | MAV 43 LES NC | 1443 |
| | 7030000200 | MAV 43 LEB OO | 1435 |

90° LEVER 5/2, 1/2"

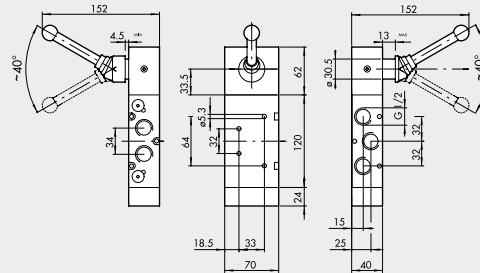

| Symbol | Code | Abbrev. | Weight [g] |
|--------|------------|---------------|------------|
| | 7030000300 | MAV 45 LES OO | 1588 |
| | 7030000400 | MAV 45 LEB OO | 1630 |

90° LEVER 5/3, 1/2"

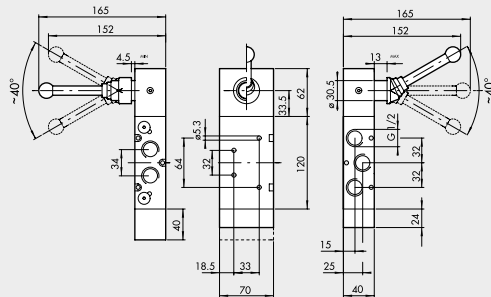

| Symbol | Code | Abbrev. | Weight [g] |
|--------|------------|---------------|------------|
| | 7030001000 | MAV 46 LES CC | 1810 |
| | 7030000900 | MAV 46 LES OC | 1800 |
| | 7030001100 | MAV 46 LES PC | 1800 |
| | 7030000500 | MAV 46 LEO CC | 1615 |
| | 7030000600 | MAV 46 LEO OC | 1605 |
| | 7030000700 | MAV 46 LEO PC | 1605 |

NOTES

VALVES

VALVES SERIES 70, HAND OPERATED