

## 3/2-way valve

electropneumatic

**PLUS** ||

Art. No. 106530

Type No. 517.112-38

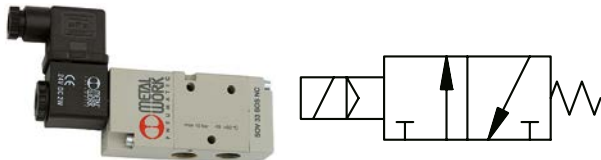

Exemplary illustration

Traditional way valves of series 70 in electropneumatic version. These valves have a wide range of applications as bushing valves, direct mounting on the cylinder with special adapters or as series valves with multi-base plates and individual interlinking plates (supply strips).

### Technical data

Operating pressure	2.5 - 10 bar
Medium temperature	-10 to 60 °C
Ambient temperature	-10 to 50 °C
Medium	Filtered compressed air with or without lubrication. If lubricated, then continuous.
Sealant	NBR
Flow rate measurement 1	Flow rate at 6 bar and $\Delta p$ 0.5 bar
Flow rate 1	1560 NI/min
Flow rate measurement 2	Flow rate at 6 bar and $\Delta p$ 1.0 bar
Flow rate 2	2150 NI/min
Connection	G 3/8
DN	13.3
Operation	Monostable
Function	3/2 NC
Manual control	latching
Series	Valves series 70
Voltage	24 V DC
Scope of delivery	with connector and coil

## Commercial data

Customs tariff number	84818079
Country of origin	IT
eCl@ss 5.1.4	27291501
eCl@ss 9.0	27291390
UNSPSC_Code_v190501	40141603
UNSPSC_CodeDesc_v190501	Pneumatic valves

## Material informations

REACH SVHC1 substance name	lead
CAS no. SVHC 1	7439-92-1
REACH Info	contains SVHC substance

## VALVES SERIES 70

The Series 70 forms part of Metal Work's full range of traditional valves.  
They are available in sizes 1/8", 1/4", 3/8" and 1/2", versions 3/2, 5/2, 5/3 and double 3/2, with mechanical, manual, pneumatic and electric drives.  
They can be installed in line, onto a wall, on the cylinder (using a special bracket) or in series (on a multiple or modular base) to suit all possible applications.

A range of valves (Series 70 LT) designed using components for specific low-temperature applications is now available for the most commonly used types and sizes.

These highly reliable valves comply with the main applicable standards, including Atex, ISO 13489 and SIL, as stated in the documents and certificates available online.



TECHNICAL DATA		1/8"	1/4"	3/8"	1/2"
Thread on the valve ports		1/8"	1/4"	3/8"	1/2"
Operating pressure series 70 versions	bar	2.5 to 10			
monostable and bistable differential		1 to 10			
bistable		vacuum to 10			
asserved					
Operating pressure series 70 LT (low temperature) versions	bar	vacuum to 10			
hand operated		vacuum to 10			-
pneumatic and solenoid/pneumatic		5 to 10			-
	t = -40°C to -10°C	3 to 10			-
	t = -10°C to +60°C				-
Minimum pilot pressure	bar	2.5			
Operating temperature range	°C	-10 to +60			
series 70 versions		-40 to +60			
series 70 LT (low temperature) versions					
Nominal diameter	mm	5	7.5	13.3	15
Conductance C	Nl/min · bar	121.43	264.26	505.52	971.43
Critical ratio b	bar/bar	0.32	0.27	0.32	0.43
Flow rate at 6 bar ΔP 0.5 bar	Nl/min	400	750	1560	3200
Flow rate at 6 bar ΔP 1 bar	Nl/min	550	1100	2150	4600
Installation		In any position (vertical assembly is not recommended for bistable valves subjected to vibration)			
Fluid		Filtered air without lubrication; lubrication, if used, must be continuous.			
Recommended lubricant		For series 70 LT (low-temperature) versions, it is recommended to use of perfortemente dried air. ISO and UNI FD 22			
Maximum coil nut torque	Nm	For series 70 LT (low-temperature) it is not expected to be used with lubricated air. 1			
Compatibility with oils		See chapter Z1			

### COMPONENTS SERIES 70

- ① VALVE BODY: Aluminium
- ② CONTROL/END CAP: plastic
- ③ SPOOL: chemically nickel-plated aluminium
- ④ DISTANCE PLATES: plastic
- ⑤ GASKETS: NBR
- ⑥ PISTONS: Hostaform®
- ⑦ PISTON GASKET: NBR
- ⑧ FILTER: plastic
- ⑨ SPRINGS: special steel
- ⑩ OPERATOR: Brass pipe - Stainless steel core



**COMPONENTS SERIES 70 LT (LOW TEMPERATURE)**

- ① ALVE BODY: aluminium
- ② CONTROL/END CAP: aluminium
- ③ SPOOL: chemically nickel-plated aluminium
- ④ DISTANCE PLATES: plastic
- ⑤ GASKETS: HNBR
- ⑥ PISTONS: aluminium
- ⑦ PISTON GASKET: HNBR
- ⑧ FILTER: plastic
- ⑨ SPRINGS: special steel
- ⑩ OPERATOR: brass pipe - Stainless steel core  
(version specific for low-temperature applications)



VALVES

VALVES SERIES 70

**FLOW CHARTS**

**VALVES SERIES 70 1/8"**

Flow rates



**VALVES SERIES 70 1/4"**

Flow rates



**VALVES SERIES 70 3/8"**

Flow rates



**VALVES SERIES 70 1/2"**

Flow rates





**VALVES SERIES 70, SOLENOID/PNEUMATIC**

TECHNICAL DATA		1/8"	1/4"	3/8"	1/2"
Operating pressure:					
• monostable and bistable differential	bar	2.5 to 10			
• bistable	bar	1 to 10			
• asserved	bar	Vacuum to 10			
Minimum pilot pressure	bar	2.5			
Operating temperature range	°C	-10 to +60			
Nominal diameter	mm	5	7.5	13.3	15
Conductance C	NI/min · bar	121.43	264.26	505.52	971.43
Critical ratio b	bar/bar	0.32	0.27	0.32	0.43
Flow rate at 6 bar ΔP 0.5 bar	NI/min	400	750	1560	3200
Flow rate at 6 bar ΔP 1 bar	NI/min	550	1100	2150	4600
TRA / TRR monostable at 6 bar	ms	15/35	19/45	21/72	36/100
TRA / TRR bistable at 6 bar	ms	20/20	21/21	18/18	25/25
Coil voltage values		12; 24 VDC - 24; 110; 220V AC 50/60Hz			
Power		2 W (DC) 3.5VA (AC)			
Voltage tolerance	%	-10 to +15			
Insulation class		F 155			
Maximum coil nut torque	Nm	1			
Hand operator		Bistable			



VALVES

**SYNOPTIC, SIZES AND VERSIONS**

SOV FAMILY	2 DIMENSIONS	3 FUNCTION	SO OPERATORS 14	S RESETTING (12)	NC FURTHER DETAILS
SOV solenoid/ pneumatic	2 1/8"	3 3/2	SO solenoid	S mechanical springs	OO no indication
	3 1/4"	5 5/2	SE solenoid assisted	B bistable	NC normally closed
	C 3/8"	6 5/3		D differential	NO normally open
	4 1/2"	■ 8 2-3/2		P pneumatic	CC closed centres
				◆ A pneumatic/mechanical spring	OC open centres
					PC pressure centres
					▲ NC-NO normally closed - normally open

- Only available for size 1/8" and 1/4"
- ◆ On demand
- ▲ Only available for function 2-3/2

VALVES SERIES 70, PNEUMATIC

**VALVES SERIES 70, SOLENOID/PNEUMATIC, PILOT-ASSISTED SOLENOID/PNEUMATIC, 1/8"**

**MONOSTABLE 3/2 NO, 1/8"**



Symbol	Code	Abbrev.	Weight [g]
	7010020400	SOV 23 SOS NO	100

**MONOSTABLE 3/2 NC, 1/8"**



Symbol	Code	Abbrev.	Weight [g]
	7010020200	SOV 23 SOS NC	100
	7010020500	SOV 23 SES NC	100





MONOSTABLE 5/2, 1/4"

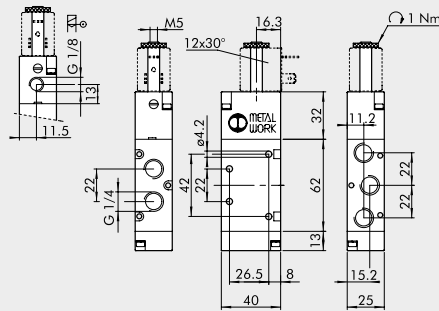

Symbol	Code	Abbrev.	Weight [g]
	7020021100	SOV 35 SOS OO	200
	7020021500	SOV 35 SES OO	200

BISTABLE 5/2, 1/4"

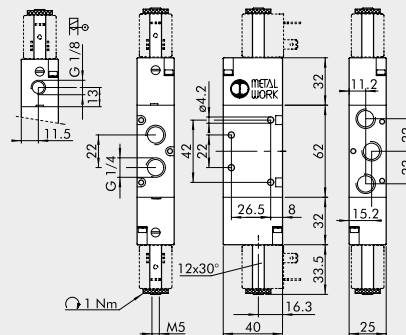

Symbol	Code	Abbrev.	Weight [g]
	7020021200	SOV 35 SOB OO	236
	7020021300	SOV 35 SOD OO	252
	7020021600	SOV 35 SEB OO	242

BISTABLE 3/2, 1/4"



Symbol	Code	Abbrev.	Weight [g]
	7020020100	SOV 33 SOB OO	190
	7020020300	SOV 33 SEB OO	190

DOUBLE 3/2, 1/4"



Symbol	Code	Abbrev.	Weight [g]
	7020023100	SOV 38 SOS NC	286
	7020023200	SOV 38 SOS NO	286
	7020023300	SOV 38 SOS NC-NO	286
	7020023400	SOV 38 SES NC	286
	7020023500	SOV 38 SES NO	286
	7020023600	SOV 38 SES NC-NO	286





MONOSTABLE 5/2, 3/8"



Symbol	Code	Abbrev.	Weight [g]
	7040021100	SOV C5 SOS OO	361
	7040021500	SOV C5 SES OO	361

BISTABLE 5/2, 3/8"

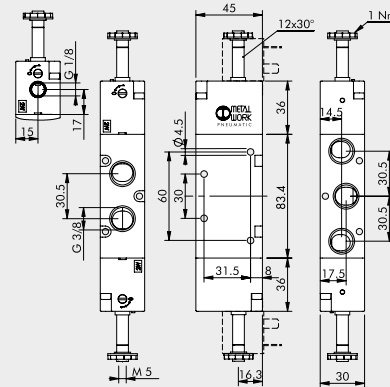

Symbol	Code	Abbrev.	Weight [g]
	7040021200	SOV C5 SOB OO	400
	7040021300	SOV C5 SOD OO	425
	7040021600	SOV C5 SEB OO	400

BISTABLE 3/2, 3/8"



Symbol	Code	Abbrev.	Weight [g]
	7040020100	SOV C3 SOB OO	307
	7040020300	SOV C3 SEB OO	307

MONOSTABLE 5/3, 3/8"

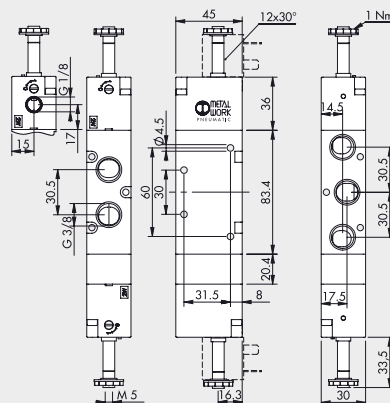

Symbol	Code	Abbrev.	Weight [g]
	7040022100	SOV C6 SOS CC	476
	7040022200	SOV C6 SOS OC	474
	7040022300	SOV C6 SOS PC	474
	7040022400	SOV C6 SES CC	476
	7040022500	SOV C6 SES OC	474
	7040022600	SOV C6 SES PC	474

**VALVES SERIES 70, SOLENOID/PNEUMATIC,  
PILOT-ASSISTED SOLENOID/PNEUMATIC, 1/2"**

**MONOSTABLE 3/2 NO, 1/2"**



**MONOSTABLE 3/2 NC, 1/2"**



Symbol	Code	Abbrev.	Weight [g]
	7030020400	SOV 43 SOS NO	660

Symbol	Code	Abbrev.	Weight [g]
	7030020200	SOV 43 SOS NC	660
	7030020500	SOV 43 SES NC	654

**MONOSTABLE 5/2, 1/2"**

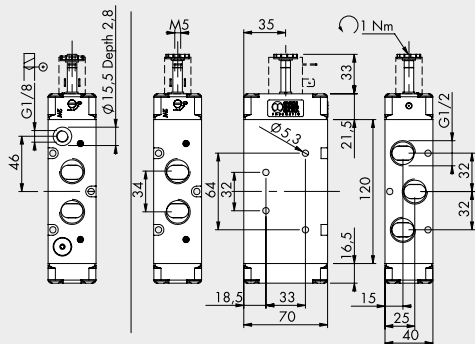

**BISTABLE 5/2, 1/2"**



Symbol	Code	Abbrev.	Weight [g]
	7030021100	SOV 45 SOS OO	828
	7030021500	SOV 45 SES OO	830

Symbol	Code	Abbrev.	Weight [g]
	7030021200	SOV 45 SOB OO	860
	7030021300	SOV 45 SOD OO	868
	7030021600	SOV 45 SEB OO	854

VALVES

VALVES SERIES 70, SOLENOID/PNEUMATIC

**BISTABLE 3/2, 1/2"**

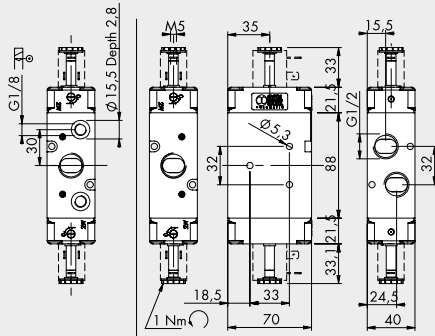

**MONOSTABLE 5/3, 1/2"**



Symbol	Code	Abbrev.	Weight [g]
	7030020100	SOV 43 SOB OO	686
	7030020300	SOV 43 SEB OO	678

Symbol	Code	Abbrev.	Weight [g]
	7030022100	SOV 46 SOS CC	1265
	7030022200	SOV 46 SOS OC	1265
	7030022300	SOV 46 SOS PC	1265
	7030022400	SOV 46 SES CC	1252
	7030022500	SOV 46 SES OC	1252
	7030022600	SOV 46 SES PC	1252

**ACCESSORIES FOR SERIES 70 SOLENOID/PNEUMATIC VALVES**

Refer to page B1.60 for coils and connectors



**NOTES**

## COILS AND CONNECTORS FOR SERIES 70, NAMUR AND SERIES BASIC VALVES

VALVES

COILS AND CONNECTORS FOR SERIES 70, NAMUR AND SERIES BASIC VALVES

### COILS SIDE 22 mm

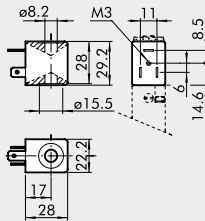

- Voltage tolerance: -10% + 15%
- Insulation class: F155
- Degree of protection: IP65 DIN 40050 with connector
- Avoid prolonged exposure to atmospheric agents
- Coil temperature 100% ED: 55°C at 20°C ambient temperature
- According to Atex 2014/34/EU rule, group 2, category 3 GD
- Electrical connection DIN 43650 B-IND

Code	Abbrev.	Nominal voltage	Absorption	
			Inrush	Holding
W0215000151	Coil 22 Ø 8 BA 2W-12VDC	12Vcc	2W	2W
W0215000101	Coil 22 Ø 8 BA 2W-24VDC	24Vcc	2W	2W
W0215000111	Coil 22 Ø 8 BA 3.5VA-24VAC	24V 50/60Hz	5.3VA	3.5VA
W0215000121	Coil 22 Ø 8 BA 3.5VA-110VAC	110V 50/60Hz	5.3VA	3.5VA
W0215000131	Coil 22 Ø 8 BA 3.5VA-220VAC	220V 50/60Hz	5.3VA	3.5VA

### "UL" AND "CSA" COILS 22 mm

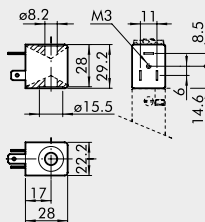

- Voltage tolerance: -10% to + 15%
- Insulation class: F155
- Degree of protection: IP65 EN60529 with connector
- Avoid prolonged exposure to the atmospheric agents
- Coil temperature 100% ED: 55°C at 20°C ambient temperature
- Electrical connection DIN 43650 B-IND

Code	Abbrev.	Nominal voltage	Absorption	
			Inrush	Holding
W0215000251	Coil 22 Ø 8 BA 2W-12VDC UR	12Vcc	2W	2W
W0215000201	Coil 22 Ø 8 BA 2W-24VDC UR	24Vcc	2W	2W
W0215000211	Coil 22 Ø 8 BA 3.5VA-24VAC UR	24V 50/60Hz	5.3VA	3.5VA
W0215000221	Coil 22 Ø 8 BA 3.5VA-110VAC UR	110V 50/60Hz	5.3VA	3.5VA
W0215000231	Coil 22 Ø 8 BA 3.5VA-220VAC UR	220V 50/60Hz	5.3VA	3.5VA

### CONNECTOR FOR COILS SIDE 22 mm DIN 43650 B-IND

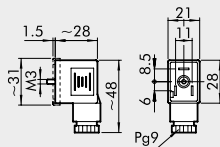

Code	Tipo	Colour	Ø Cable
W0970510011	Standard	Black	PG9
W0970510012	LED 24V	Transparent	PG9
W0970510013	LED 110V	Transparent	PG9
W0970510014	LED 220V	Transparent	PG9
W0970510015	LED + VDR 24V	Transparent	PG9
W0970510016	LED + VDR 110V	Transparent	PG9
W0970510017	LED + VDR 220V	Transparent	PG9
W0970510070	Atex II 2 GD	Black	PG9

### KIT COIL EEXM

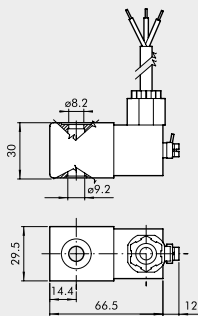

Code	Description
0227606913	Kit for coil 30 24VDC EEXMT5 cable 3 m
0227606915	Kit for coil 30 24VDC EEXMT5 cable 5 m
0227608013	Kit for coil 30 24VAC EEXMT5 cable 3 m
0227608015	Kit for coil 30 24VAC EEXMT5 cable 5 m
0227608023	Kit for coil 30 110VAC EEXMT5 cable 3 m
0227608025	Kit for coil 30 110VAC EEXMT5 cable 5 m
0227608033	Kit for coil 30 230VAC EEXMT5 cable 3 m
0227608035	Kit for coil 30 230VAC EEXMT5 cable 5 m

According to Atex 2014/34/EU rule:  $\text{Ex}$  II 2G Ex mb IIC T4/T5 Gb  
 $\text{Ex}$  II 2D Ex tb IIIC T130/T95 °C IP66 Db

N.B.: Supplied complete with adapter for Ø8 mm sleeve.  
 N.B.: It's not possible to mount valves having these coils on bases or on manifolds, because the width of 29.5 mm is higher than the distance between the valves. Special bases can be manufactured on request.

### KIT COILS SIDE 22 IP65



Code	Description
0222100100	Kit for coils 22 - IP65

Improved IP65 protection, even after prolonged exposure to atmospheric agents.  
 Applicable to valves with a technopolymer control.

## Spareparts

	Art. No.	Type No.
Solenoid 24 V AC, 50/60 Hz, 5 VA	118633	400-517-01
Solenoid 110 V AC, 50/60 Hz, 5 VA	118634	400-517-07
Solenoid 230 V AC, 50/60 Hz, 5 VA	118635	400-517-17
Solenoid 12 V DC, 5 W	118636	400-517-41
Solenoid 24 V DC, 5 W	118637	400-517-42
Solenoid 24 V AC, 50/60 Hz, 3,5 VA	118628	400-514-01
Solenoid 110 V AC, 50/60 Hz, 3,5 VA	118629	400-514-07
Solenoid 230 V AC, 50/60 Hz, 3,5 VA	118630	400-514-17
Solenoid 12 V DC, 2 W	118631	400-514-41
Solenoid 24 V DC, 2 W	118632	400-514-42
Plug connector, standard, industrial form B, black	117313	1920.9P
Plug connector with LED, 230 V, transparent	117314	1920.9PL.17
Plug connector with LED, 24 V, transparent	117316	1920.9PL.42
Plug connector with LED, varistor 230 V, transparent	117317	1920.9PLV17
Plug connector with LED, varistor 24 V, transparent	117318	1920.9PLV42
Plug connector with LED, 110 V, transparent	151011	1920.9PL110
Plug connector, ATEX II 2 GD, black	123182	1920.9PL2GD-EX
Plug connector with LED, varistor 110 V, transparent	129849	1920.9PLV110