

Supply strip

for the pilot valves, pneumatic and electro-pneumatic

Art. No. 106610

Type No. 518.02-18



Exemplary illustration

Quick and easy assembly system for side-by-side mounting of the above control valve types. Requires one set of mounting brackets and a feed block.

Not for 5/2-way spool valves - Robust type and 3A, 4A, 3V, 4V type.

Technical data

| | |
|----------------|-----------------------------------|
| Description | Feed block with 2 valve positions |
| Material | aluminium |
| For valve port | G 1/8 |
| Version | with 2 screws and 2 seals |

Commercial data

| | |
|-------------------------|---------------|
| Customs tariff number | 84819000 |
| Country of origin | IT |
| eCl@ss 5.1.4 | 27294206 |
| eCl@ss 9.0 | 27294206 |
| UNSPSC_Code_v190501 | 27131601 |
| UNSPSC_CodeDesc_v190501 | Air manifolds |

Material informations

| | |
|----------------------------|-------------------------|
| REACH SVHC1 substance name | lead |
| CAS no. SVHC 1 | 7439-92-1 |
| RoHS materials notice | RoHS compliant |
| REACH Info | contains SVHC substance |

ACCESSORIES: 1/8 MANIFOLDS FOR SERIES 70 PNV-SOV AND SERIES BASIC VALVES

MANIFOLD WITH 2 TO 7 POSITIONS + FITTINGS

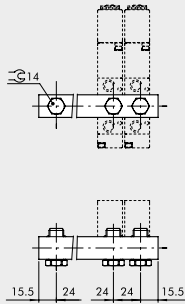

| Code | Description | Weight [g] |
|------------|-------------|------------|
| 0221000200 | CSA-18-02 | 70 |
| 0221000300 | CSA-18-03 | 99 |
| 0221000400 | CSA-18-04 | 131 |
| 0221000500 | CSA-18-05 | 162 |
| 0221000600 | CSA-18-06 | 192 |
| 0221000700 | CSA-18-07 | 229 |

BRACKET SET H120

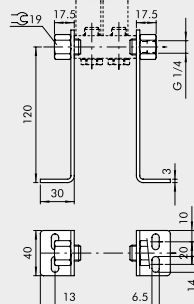

| Code | Description | Weight [g] |
|------------|-------------|------------|
| 0221000190 | CSA-18-OO | 309 |

BRACKET SET H60

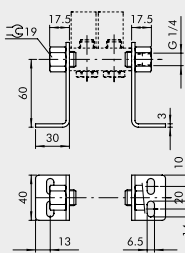

| Code | Description | Weight [g] |
|------------|-------------|------------|
| 0221000191 | CSA-18-OC | 213 |

BRACKET SET H30

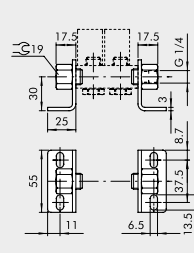

| Code | Description | Weight [g] |
|------------|-------------|------------|
| 0221000192 | CSA-18-OE | 181 |

VALVES

ACCESSORIES FOR VALVES SERIES 70

ACCESSORIES: 1/4 MANIFOLDS FOR SERIES 70 PNV-SOV AND SERIES BASIC VALVES

MANIFOLD WITH 2 TO 7 POSITIONS + FITTINGS

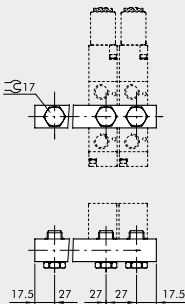

| Code | Description | Weight [g] |
|------------|-------------|------------|
| 0222000200 | CSA-14-02 | 89 |
| 0222000300 | CSA-14-03 | 131 |
| 0222000400 | CSA-14-04 | 174 |
| 0222000500 | CSA-14-05 | 213 |
| 0222000600 | CSA-14-06 | 252 |
| 0222000700 | CSA-14-07 | 328 |

BRACKET SET H120

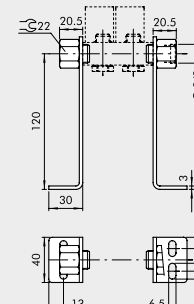

| Code | Description | Weight [g] |
|------------|-------------|------------|
| 0222000190 | CSA-14-OO | 338 |

BRACKET SET H60

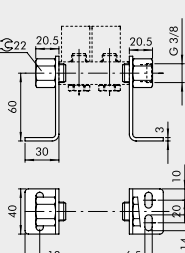

| Code | Description | Weight [g] |
|------------|-------------|------------|
| 0222000191 | CSA-14-OC | 242 |

BRACKET SET H30

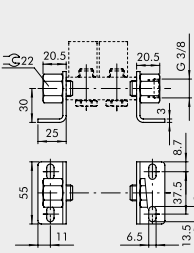

| Code | Description | Weight [g] |
|------------|-------------|------------|
| 0222000192 | CSA-14-OE | 209 |

ACCESSORIES: MANIFOLD BASES FOR SERIES 70 PNV-SOV AND SERIES BASIC VALVES

MODULAR BASES FOR SERIES 70 SOV-PNV VALVES

VALVES

ACCESSORIES FOR VALVES SERIES 70

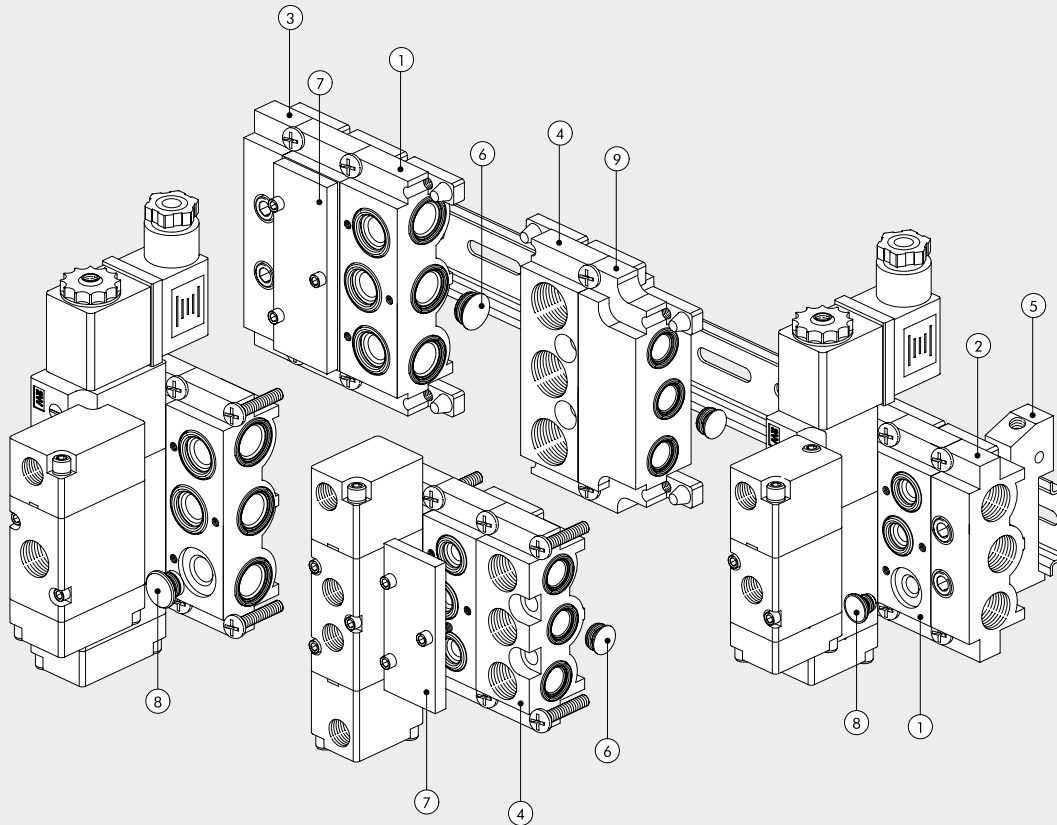

| Reference | 1/8" | 1/4" | Description |
|-----------|------------|------------|----------------------------------|
| ① | 0226004150 | 0226005150 | Modular manifold base |
| ② | 0226004201 | 0226005201 | End plate without OR |
| ③ | 0226004200 | 0226005200 | End plate with OR |
| ④ | 0226004300 | 0226005300 | Intermediate part for upper feed |
| ⑤ | 0226004600 | 0226005600 | Adapter for omega bar |
| ⑥ | 0226004000 | 0226005000 | Intermediate diaphragm |
| ⑦ | 0226004500 | 0226005500 | Blanking plate |
| ⑧ | 0226004001 | 0226005001 | 3/2 cap |
| ⑨ | 0226006600 | - | Dimensional adapter |

① MODULAR BASE MANIFOLD

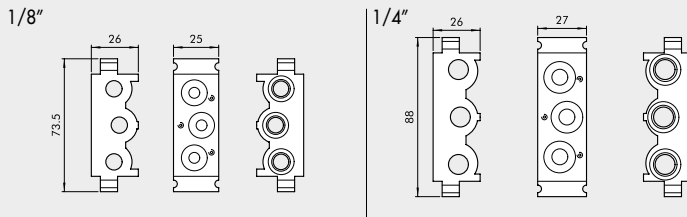

| Code | Description | Weight [g] |
|------------|----------------------------|------------|
| 0226004150 | Modular base MANIFOLD 1/8" | 110 |
| 0226005150 | Modular base MANIFOLD 1/4" | 131 |

② END PLATE WITHOUT OR

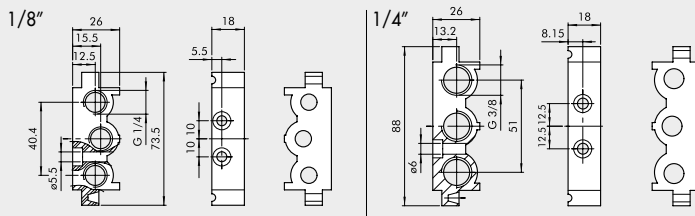

| Code | Description | Weight [g] |
|------------|---------------------------|------------|
| 0226004201 | End plate without OR 1/8" | 52 |
| 0226005201 | End plate without OR 1/4" | 57 |

③ END PLATE WITH OR

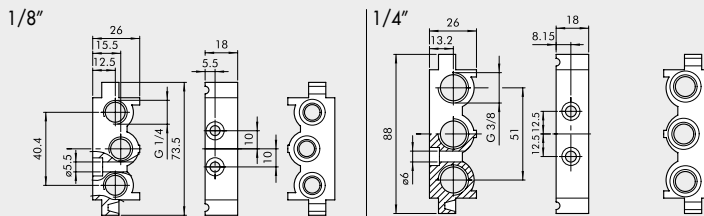

| Code | Description | Weight [g] |
|------------|------------------------|------------|
| 0226004200 | End plate with OR 1/8" | 74 |
| 0226005200 | End plate with OR 1/4" | 80 |

④ INTERMEDIATE PART FOR UPPER FEED

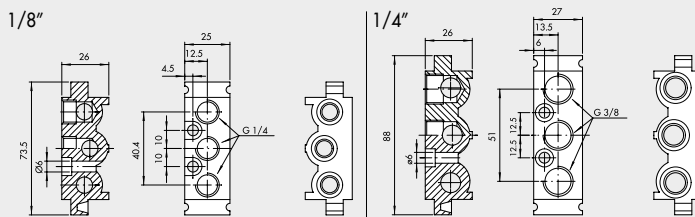

| Code | Description | Weight [g] |
|------------|---------------------------------------|------------|
| 0226004300 | Intermediate part for upper feed 1/8" | 93 |
| 0226005300 | Intermediate part for upper feed 1/4" | 109 |

⑤ ADAPTER FOR OMEGA BAR BASES (DIN EN 50022)

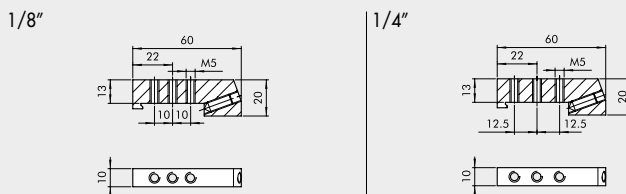

| Code | Description | Weight [g] |
|------------|--------------|------------|
| 0226004600 | Adapter 1/8" | 46 |
| 0226005600 | Adapter 1/4" | 46 |

N.B.: Also for multiple bases

VALVES

ACCESSORIES FOR VALVES SERIES 70

⑥ INTERMEDIATE DIAPHRAM

1/8"

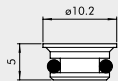

1/4"

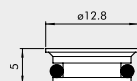

| Code | Description | Weight [g] |
|------------|-----------------------------|------------|
| 0226004000 | Intermediate diaphragm 1/8" | 2 |
| 0226005000 | Intermediate diaphragm 1/4" | 3 |

⑦ BLANKING PLATE FOR UNUSED POSITIONS

1/8"

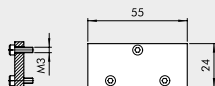

1/4"

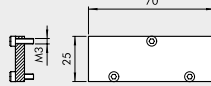

| Code | Description | Weight [g] |
|------------|---------------------|------------|
| 0226004500 | Blanking plate 1/8" | 23 |
| 0226005500 | Blanking plate 1/4" | 29 |

⑧ PLUG FOR 3/2

1/8"

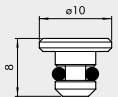

1/4"

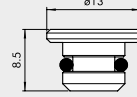

| Code | Description | Weight [g] |
|------------|-------------------------|------------|
| 0226004001 | Blanking plate 3/2 1/8" | 2 |
| 0226005001 | Blanking plate 3/2 1/4" | 4 |

⑨ DIMENSIONAL ADAPTER 1/8" - 1/4"

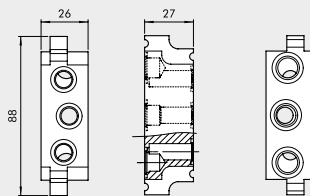

| Code | Description | Weight [g] |
|------------|--------------------|------------|
| 0226006600 | Adapter 1/8", 1/4" | 177 |

NOTES

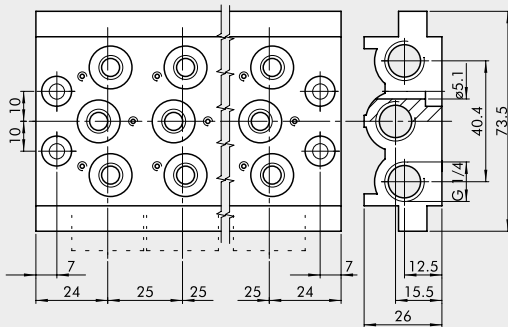
ACCESSORIES: MULTIPLE BASES FOR SERIES 70 PNV-SOV VALVES
MULTIPLE BASE 1/8"

| Code | Description | Abbrev. | Weight [g] |
|------------|------------------|-----------|------------|
| 0223000201 | 2-position base | CVM-18-02 | 236 |
| 0223000301 | 3-position base | CVM-18-03 | 321 |
| 0223000401 | 4-position base | CVM-18-04 | 407 |
| 0223000501 | 5-position base | CVM-18-05 | 494 |
| 0223000601 | 6-position base | CVM-18-06 | 587 |
| 0223000701 | 7-position base | CVM-18-07 | 711 |
| 0223000801 | 8-position base | CVM-18-08 | 760 |
| 0223000901 | 9-position base | CVM-18-09 | 842 |
| 0223001001 | 10-position base | CVM-18-10 | 923 |

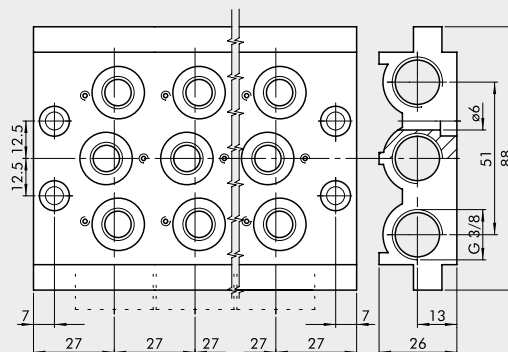
MULTIPLE BASE 1/4"

| Code | Description | Abbrev. | Weight [g] |
|------------|------------------|-----------|------------|
| 0224000201 | 2-position base | CVM-14-02 | 296 |
| 0224000301 | 3-position base | CVM-14-03 | 406 |
| 0224000401 | 4-position base | CVM-14-04 | 515 |
| 0224000501 | 5-position base | CVM-14-05 | 624 |
| 0224000601 | 6-position base | CVM-14-06 | 733 |
| 0224000701 | 7-position base | CVM-14-07 | 845 |
| 0224000801 | 8-position base | CVM-14-08 | 956 |
| 0224000901 | 9-position base | CVM-14-09 | 1055 |
| 0224001001 | 10-position base | CVM-14-10 | 1086 |

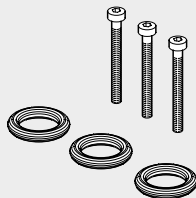
GASKET KIT

| Code | Description | Weight [g] |
|------------|--------------------------|------------|
| 0226004701 | Gasket kit for 1/8" base | 5 |
| 0226005701 | Gasket kit for 1/4" base | 5 |

VALVES

ACCESSORIES FOR VALVES SERIES 70