

# Push-in L-fitting

»metallica« series

**PLUS**

Art. No. 108900

Type No. 854.014-6

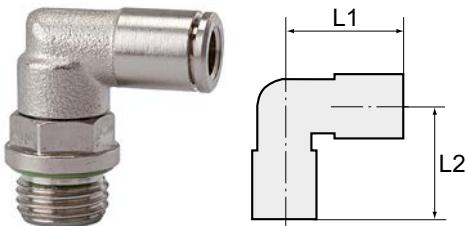

Exemplary illustration

All parts with a parallel thread are supplied with an FPM O-ring while the conical threads are coated with preCOTE 5 dispersion; all fittings in this series can thus also be used at high temperatures (medium compressed air).

## Technical data

Working pressure	-0.98 - 16 bar
Operating temperature	-20 to 150 °C
Series	metallica
Material	Nickel-plated brass
Medium	Compressed air
Sealant	FKM
Sleeve	Nickel-plated brass
Clamping ring	Stainless steel
Applications	Compressed air systems, welding technology, vacuum
Recommended hose	PA and PU
Thread form	parallel male thread
Version	with O-ring
Design	swivel type
Thread	G 1/4
For tube O.D.	6 mm
L1	21.0 mm
L2	24.0 mm
a/f	13 mm

## Commercial data

Customs tariff number	74122000
Country of origin	IT
eCl@ss 5.1.4	27294201
eCl@ss 9.0	27294201
UNSPSC_Code_v190501	27131613
UNSPSC_CodeDesc_v190501	Air coupling

## Material informations

REACH SVHC1 substance name	lead
CAS no. SVHC 1	7439-92-1
RoHS materials notice	RoHS compliant
REACH Info	contains SVHC substance

## Dimensions

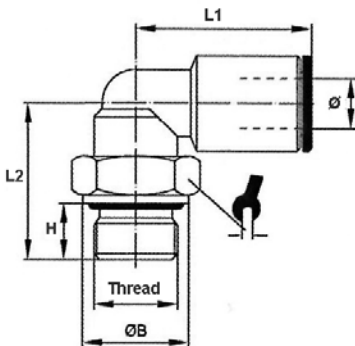

Thread	For tube O.D.	Ø B	H	a/f	L1	L2
	mm	mm	mm	mm	mm	mm
G 1/4	6	16.0	8.0	13	21.0	24.0

## Accessories

	Art. No.	Type No.
Loosening tool, quick-connect fittings, hose exterior Ø 3 - 10 mm	108853	LW3-10
Loosening tool, quick-connect fittings, hose exterior Ø 4-14 mm	121863	LW4-14
Plug nipple »metallica«, hose exterior Ø 6, nickel-plated brass	142788	8865.006
Locking plug »value line«, Supports 6 mm, nickel-plated brass	116300	58.006-E