

# Articulated carrier

ZRL1 series

Art. No. 129658

Type No. KBW.ZRL1C.25



Exemplary illustration

## Technical data

For cylinders	ZRL1C
Suitable for piston Ø	25 mm
Version	1 piece incl. bolt

## Commercial data

Customs tariff number	84129080
Country of origin	DE
eCl@ss 5.1.4	27299202
eCl@ss 9.0	27299202
UNSPSC_Code_v190501	27131708
UNSPSC_CodeDesc_v190501	Mounting bases for pneumatic cylinder

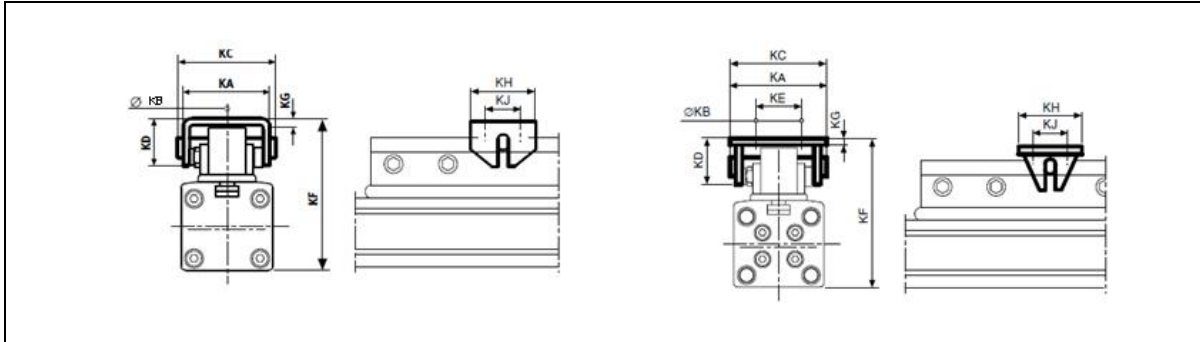
**Articulated carrier for ZRL1C - 1 piece incl. bolt**

Art. No.	Type No.	Ø	KA	KB	KC	KD	KE	KF*	KG	KH	KJ
129657	KBW.ZRL1C.16	16	25	4.5	28	12	-	47-50	2	20	10
129658	KBW.ZRL1C.25	25	37	5.5	42	20	-	72-75	3	30	16
129659	KBW.ZRL1C.32	32	70	7.0	70	38	55	91-100	5	90	75
129660	KBW.ZRL1C.40	40	70	7.0	70	38	55	111-120	5	90	75

\*Variable within the length of the available fork depth.



KBW.ZRL1C.40