

Articulated carrier

ZRL1 series

Art. No. 129661

Type No. KBW.ZRL1F.16



Exemplary illustration

Technical data

For cylinders	ZRL1F
Suitable for piston Ø	16 mm
Version	1 piece with 4 screws and 4 washers

Commercial data

Customs tariff number	84129080
Country of origin	DE
eCl@ss 5.1.4	27299202
eCl@ss 9.0	27299202
UNSPSC_Code_v190501	27131708
UNSPSC_CodeDesc_v190501	Mounting bases for pneumatic cylinder

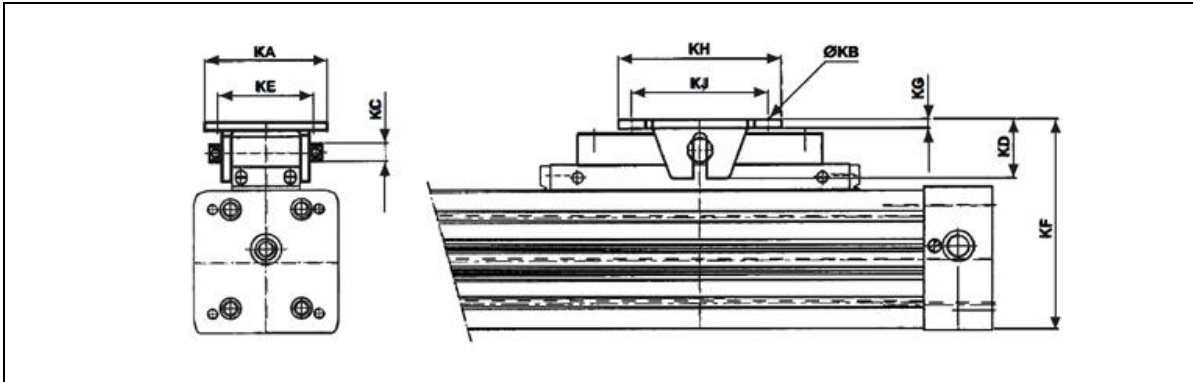
Articulated carrier for ZRL1F - 1 piece with 4 screws and 4 washers

Art. No.	Type No.	Ø	KA	KB	KC	KD	KE	KF*	KG	KH	KJ
129661	KBW.ZRL1F.16	16	26	M4	3.5	10.0	10	46.5-47.5	3.0	28	20
129662	KBW.ZRL1F.25	25	38	M5	8.0	19.0	16	71.5-73.5	3.5	40	30
129663	KBW.ZRL1F.32	32	62	M6	12.0	28.0	25	94.5-96.5	6.0	60	46
129664	KBW.ZRL1F.40	40	62	M6	12.0	28.0	25	108-110	6.0	60	46
129665	KBW.ZRL1F.50	50	90	9	15.0	43.7	70	135-150	6.4	120	100
129666	KBW.ZRL1F.63	63	90	9	15.0	43.7	70	155-170	6.4	120	100

* Variable within the length of the available fork depth.



KBW.ZRL1F.16