

# Push-in L-fitting

stainless steel

## STAINLESS STEEL

Art. No. 135153

Type No. 854.012-12 ES

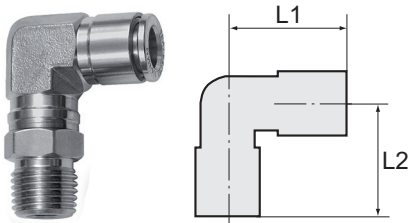

Exemplary illustration

For use in more aggressive environments and corrosive media.  
The suitability test for the individual application is the user's responsibility.

## Technical data

Working pressure	-0.98 - 20 bar
Operating temperature	-20 to 150 °C
Medium temperature	-20 to 150 °C
Material	Stainless steel 1.4404
Medium	Compressed air,corrosive media (if compatible with material)
Sealant	FPM
Applications	Compressed air syst.,chemical and food, pharma, pack.,vacuum
Thread form	Conical male thread
Standard thread	ISO 7-1
Design	Swivel type
Thread	R 1/2
For tube O.D.	12 mm
L1	26.7 mm
L2	39.4 mm
a/f	22 mm
a/f 1	19 mm
Suitable pipe materials	PVDF, PTFE, PA, PU

The suitability test for the use with alternative specifications is the user's responsibility.

## Commercial data

Customs tariff number	73072910
Country of origin	IN
eCl@ss 5.1.4	27294201
eCl@ss 9.0	27294201
UNSPSC_Code_v190501	27131613
UNSPSC_CodeDesc_v190501	Air coupling

## Material informations

REACH SVHC1 substance name	no
CAS no. SVHC 1	no CAS No.
RoHS materials notice	RoHS compliant
REACH Info	no SVHC substance included

## Dimensions

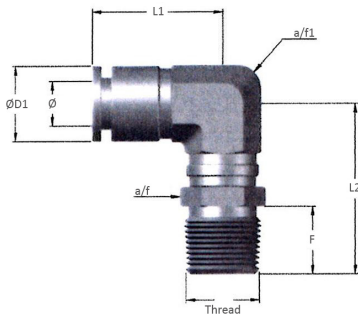

Thread	Standard thread	For tube O.D.	F	a/f	a/f 1	L1	L2	D1
		mm	mm	mm	mm	mm	mm	mm
R 1/2	ISO 7-1	12	15.0	22	19	26.7	39.4	19.0

## Accessories

	Art. No.	Type No.
Loosening tool, quick-connect fittings, hose exterior Ø 4-14 mm	121863	LW4-14