

Filter regulator

»SYNTESI« series

PLUS

Art. No. 141266

Type No. 5623B163



Exemplary illustration

Filter regulators based on the »SYNTESI« series filters and regulators, combining their performance and advantages.

- Condensate drains RMSA semi-automatic or RA fully automatic. SAC fully automatic on request.
- Degree of filtration 20 µm (sufficient for most applications) or 5 µm. 50 µm on request.
- Regulator with rolling diaphragm with maximum precision and flow rate as well as minimal friction.
- Compensation of upstream pressure changes.

The RA drain discharges condensate from the container automatically whenever necessary, regardless of the pressure level. The SAC tap drains the condensate only as the result of sudden changes in compressed air requests.

The adjustment knob is the push-lock type with the additional possibility to secure with padlocks. There is a port on the front and back (G 1/8 for size 1 and G 1/4 for size 2) which can be used for pressure gauges, pressure switches or, taking into account the high flow rates, as an additional air outlet.

Pressure gauge not included in delivery!

Technical data

Series	Syntesi
Size	2
Max. input pressure	13 bar
Temperature range	-10 to 50 °C
Control range	0 - 12 bar
Input	G 3/8
Output	G 3/8
Front and back port thread	G 1/4
Flow rate measurement 1	at $P_1 = 10$ bar, $P_2 = 6.3$ bar and pressure drop $\Delta_p = 0.5$ bar
Flow rate 1	3200 NI/min
Flow rate measurement 2	at $P_1 = 10$ bar, $P_2 = 6.3$ bar and pressure drop $\Delta_p = 1$ bar
Flow rate 2	5800 NI/min
Filter rating	5 μ m
Condensate drain	RMSA semi-automatic
Output air purity class according to ISO 8573-1	3.7.4
Medium	Compressed air or other neutral gases
Housing	Technopolymer
Sealant	NBR
Diaphragms	NBR 60 Shore (hardness) with polyester fabric insert
Bowl	Technopolymer
Spring bonnet	Technopolymer
A	60.5 mm
A1	- mm
B	246.0 mm
N	139.8 mm

Commercial data

Customs tariff number	84811005
Country of origin	IT
eCl@ss 5.1.4	27292901
eCl@ss 9.0	27292990
UNSPSC_Code_v190501	27131603
UNSPSC_CodeDesc_v190501	Air regulators

SYNTESI® FILTER-REGULATOR

This device combines in a single unit the functions of filtration, condensate separation and pressure regulation.

It is made up of the same elements forming the filter and the regulator, so the performance and advantages are the same:

- Separation of condensate and larger liquid and solid particles by centrifugation.
- Three condensate drain options (RMSA, RA and SAC).
- 360° visually inspection of the condensate level, via transport spy-holes.
- Rolling diaphragm regulator, allowing maximum precision and flow rate, and minimal friction.
- Compensation for upstream pressure changes.
- Pressure relief valve.
- Quick downstream pressure relief.
- Padlockable push-lock knob.
- Front and rear ports for pressure gauges, pressure switches or, considering the high flow rate, for use as additional filtered and regulated air take-off.

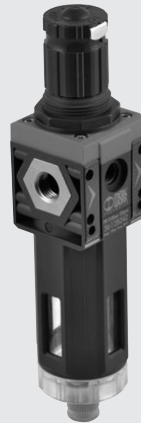

UNITS

Syntesi® FILTER-REGULATOR

TECHNICAL DATA	FR SY1			FR SY2			
	1/8"	1/4"	3/8"	3/8"	1/2"	3/4"	1"
Threaded port	5 (yellow) - output air purity class ISO8573-1: 3.7.4						
Degree of filtration	20 (white) - output air purity class ISO8573-1: 4.7.4						
	50 (blue) - output air purity class ISO8573-1: 5.7.4						
Max. inlet pressure	bar			bar			
	15			13			
	MPa			MPa			
	1.5			1.3			
	psi			psi			
	217			188			
Flow rate at 6.3 bar (0.63 MPa; 91 psi) ΔP 0.5 bar (0.05 MPa; 7 psi)	500	800	2200	3200	4300	5200	
(inlet pressure 10 bar)	18	28	78	113	152	184	
Flow rate at 6.3 bar (0.63 MPa; 91 psi) ΔP 1 bar (0.1 MPa; 14 psi)	1300	2000	3000	5800	7200	7400	
(inlet pressure 10 bar)	46	71	106	205	255	262	
Relief valve flow rate at 6.3 bar (0.63 MPa; 91 psi)	NL/min			NL/min			
	70			100			
	scfm			scfm			
	2.5			3.5			
Min/max temperature at 10 bar; 1 MPa; 145 psi	°C			°C			
	From -10 to +50			From -10 to +50			
Full outflow with zero inlet pressure	Included						
Padlockable knob	Included						
Upstream pressure compensation	Included, via balanced valve						
Weight	244	239	230	623	596	592	580
Fluid	Compressed air or other inert gases						
Mounting position	Vertical						
Additional air take-off, for pressure gauges or fittings	1/8", front and rear			1/4", front and rear			
Additional air take-off flow rate at 6.3 bar	500			1400			
(0.63 MPa; 91 psi) ΔP 1 bar (0.1 MPa; 14 psi)	18			50			
Bowl capacity	cm ³			cm ³			
	30			70			
Condensate drain	RMSA: drain with manual condensate discharge and automatic discharge at zero pressure						
	RA: automatic drain with condensate discharge, independent of pressure and flow rate.						
	Version conveys the draining by inserting the pipe having internal diameter 6 mm in the lower port.						
	SAC: automatic drain with condensate discharge. Operates by pressure drop – requires variable air take-offs.						
	Note: the maximum input pressure for the RA version must not exceed 10 bar						
	No. 2 M4 screws			No. 2 M5 screws			
Wall fixing screws							
Notes on use	The pressure must always be set upwards. For increased sensitivity, use a pressure regulator with a rated pressure as close as possible to the required value.						
	On request version without overpressure exhaust.						

COMPONENTS

- ① Technopolymer adjusting knob
- ② Technopolymer bell
- ③ Steel adjusting spring (with Geomet[®] treatment for anti-corrosion version)
- ④ Technopolymer flange
- ⑤ Rolling diaphragm
- ⑥ IN/OUT bushing made of OT58 nickel-plated brass or passivated aluminium for 3/4" - 1"
- ⑦ Technopolymer body
- ⑧ OT58 brass valve, with NBR vulcanized gasket
- ⑨ Clear technopolymer bowl
- ⑩ Zinc-plated steel plate for knob locking (stainless steel for anti-corrosion version)
- ⑪ OT58 brass adjusting screw
- ⑫ Technopolymer ring nut
- ⑬ Technopolymer plate
- ⑭ Technopolymer rod
- ⑮ Stainless steel valve spring
- ⑯ O-ring NBR gaskets
- ⑰ Drain (RMSA)
- ⑱ Sintered HDPE filter cartridge
- ⑲ Technopolymer screen



FLOW CHARTS

FR Syntesi[®] SY1 1/8"

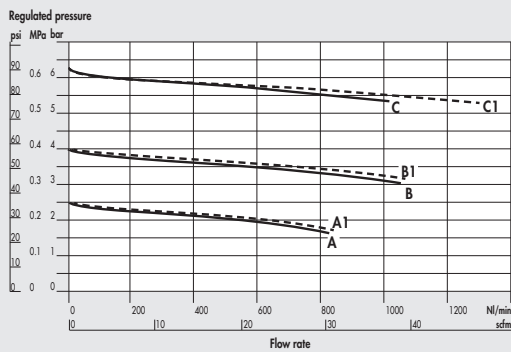

FR Syntesi[®] SY1 1/4"

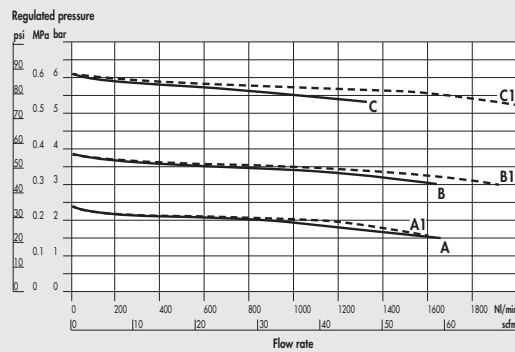

FR Syntesi[®] SY1 3/8"

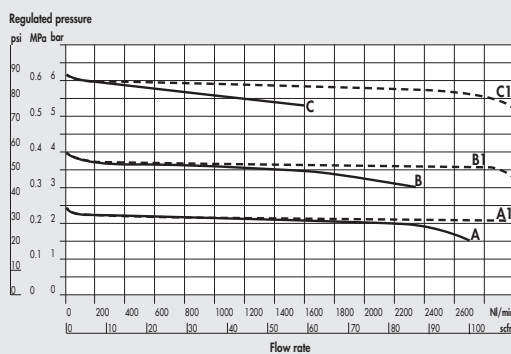

FR Syntesi[®] SY2 3/8"

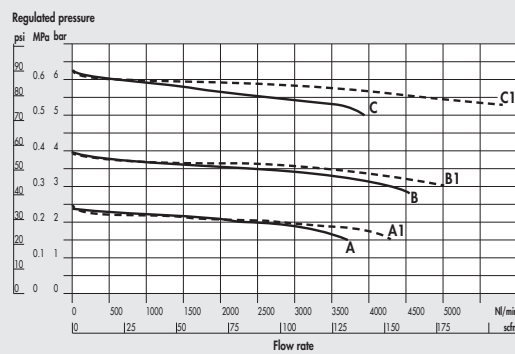

A = P In 7 bar - P Out 2.5 bar
B = P In 7 bar - P Out 4 bar

C = P In 7 bar - P Out 6.3 bar
A1 = P In 10 bar - P Out 2.5 bar

B1 = P In 10 bar - P Out 4 bar
C1 = P In 10 bar - P Out 6.3 bar

UNITS

Syntesi[®] FILTER-REGULATOR

FR Syntesi® SY2 1/2"

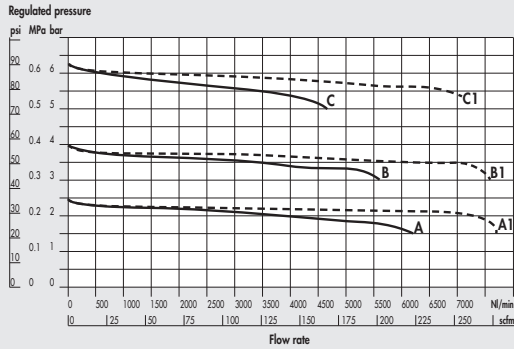

FR Syntesi® SY2 3/4" - 1"

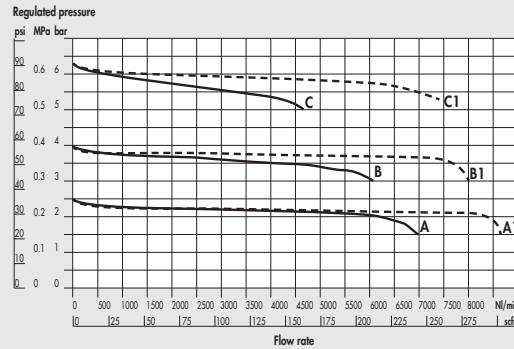

A = P In 7 bar - P Out 2.5 bar
B = P In 7 bar - P Out 4 bar

C = P In 7 bar - P Out 6.3 bar
A1 = P In 10 bar - P Out 2.5 bar

B1 = P In 10 bar - P Out 4 bar
C1 = P In 10 bar - P Out 6.3 bar

UNITS

Syntesi® FILTER-REGULATOR

DIMENSIONS

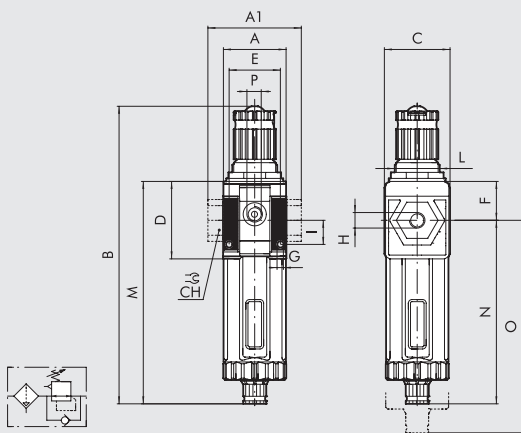

	SIZE 1			SIZE 2			
	1/8"	1/4"	3/8"	3/8"	1/2"	3/4"	1"
H (threaded port)							
A		42			60.5		
A1			44			95	95
B		198			246		
		RA/SAC			250		
C		44			61		
CH						32	36
D		51.5			70.5		
E		33.5			47.5		
F		25.8			38.2		
G		Hole for M4 screws		Hole for M5 screws			
I		16			22.5		
L		M30x1.5		M38x2			
M		148			178		
		RA/SAC			182		
N		122.2			139.8		
		RA/SAC			143.8		
O		202			245		
		RA/SAC			249		
P (pressure gauge port or additional air takes-off)		1/8"			1/4"		

NOTES

GENERAL TECHNICAL DATA SYNTESI®

Syntesi® is an important milestone achieved by Metal Work, the result of thirty years' experience producing air-treatment units. It has been studied in minute detail to obtain the best possible performance in a reduced space and with limited weight. The capacity is much higher than that of other units of the same size.

This modular unit features a very simple yet effective system that requires no brackets, stay bolts or yoke for assembling the elements.

The basic version of Syntesi® incorporates numerous functions that are not provided or are only optional with traditional units. Examples are padlockable knobs, additional pneumatic ports on the front and back, flow options from left to right or vice versa, regulators with compensation system - which are accurate even when the upstream pressure changes, with rapid downstream pressure relief - full indelible marking, automatic condensate drain even in size 1, and 360° visual inspection of oil and condensate levels. The basic materials, technopolymer and nickel-plated brass have excellent corrosion resistance. An anti-corrosion version is available with stainless steel components (screws, plates) or Geomet®-treated ones (regulator springs).



UNITS

GENERAL TECHNICAL DATA Syntesi®

TECHNICAL DATA	SIZE 1			SIZE 2			
	1/8"	1/4"	3/8"	3/8"	1/2"	3/4"	1"
Threaded port							
Max. input pressure	bar	15			13		
	MPa	1.5			1.3		
	psi	217			188		
Flow rate	See catalogue of the various elements						
Min/max temperature at 10 bar; 1 MPa; 145 psi	°C from -10 to +50			°C from -10 to +50			
Padlockable knob	The knobs of the regulators, filter regulators and standard sectioning valves can all be padlocked						
Fluid	Compressed air or other inert gases						
Mounting position	See catalogue of the various elements						
Direction of flow	Flow options right to left or vice versa						
Additional air take-off, for pressure gauges or fittings	1/8", front and rear, on all modules			1/4", front and rear, on all modules			
Wall fixing screws	No. 2 M4 screws			No. 2 M5 screws			
Certification for potentially explosive atmosphere according to ATEX 2014/34/EU rule	 II 3G Ex h IIC T5 Gc -10°C < Ta < 50°C II 3D Ex h IIIC T100 °C Dc						

ANTI-CORROSION VERSION

Differences compared to the standard version:

- stainless steel screws
- stainless steel plate for R, FR, V3V knobs
- Geomet®-treated regulator spring and filter-regulator

FIXING TO FRONT PORTS



Do not use a spanner for fixing taper threaded elements to the front ports. Mount by hand and apply a liquid sealant (not teflon®).

ROTARY BUSHINGS



3/4" and 1" bushings in Size 2 rotate freely to facilitate assembly operations.

LASER MARKING

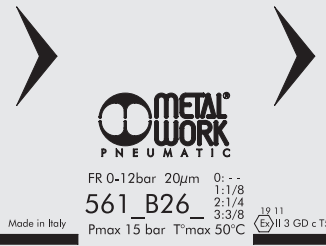

The following is marked indelibly on the body:

- Metal Work trademark
- Code
- Maximum pressure and temperature
- Degree of filtration or pressure range, where relevant
- Week and year of manufacture
- ATEX category
- Made in Italy

MOUNTING OPTIONS

On the wall, using two screws



On a panel

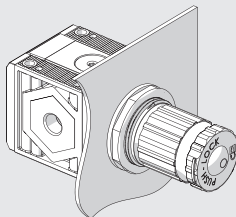

Using knob bracket

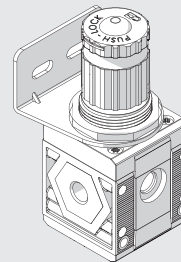

Using a bracket



The bracket can be secured in any position, and the fittings can be mounted on the pressure gauge air intake at the back of the unit.

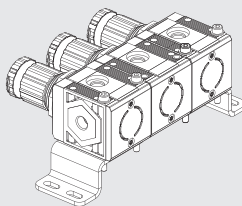

On a DIN EN50022 bar with the opposite adaptor

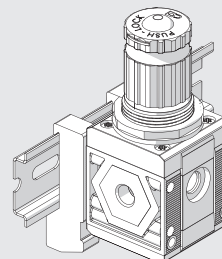

MODULARITY AND FLEXIBILITY

UNITS

GENERAL TECHNICAL DATA Syntesi®



The various elements of Syntesi® A can be connected to the air feed and delivery circuit using pneumatic nickel brass or passivated aluminium ports® and can be fixed together using nipples®.

The nipples and ports are easy to remove by unscrewing the two front screws®. This solution has numerous advantages:

- Reduced overall dimensions.
- Free composition of multiple elements, without the need for brackets, stay bolts or yoke.
- The threads for the fittings are metallic, allowing high tightening torques, also for tapered threads.
- Maximum flexibility: a unit can be transformed at any time by adding an element or replacing a port with another one, e.g. 1/4" instead of 1/8".
- The air intake port can be the same or different from the outlet port, as desired.

Standard Syntesi® ports are: 1/8", 1/4", 3/8" for size 1; 3/8", 1/2", 3/4", 1" for size 2.

It may be necessary to use a vice to insert the bushes into size 2.

The nipples have different functions:

- Nipple® joins two elements of the same size together.
- Size adaptor® can be used to connect an element in the Syntesi® 2 series with one in the Syntesi® 1 series.
- The 90° adaptor® can be used to connect two 90° angled elements. For example, it can help directing the regulator knob or the control knob of a sectioning valve towards the user.
- The two-way air intake® is a simple and cost-effective system which, besides connecting two elements together, has 2 opposing threaded air intakes.
- The adaptor for Regtronic® can be used to fix the Regtronic 1/4" proportional valve to a Syntesi® size 1 element.

Additional ports®. On the front and back of ALL Syntesi® elements there is a port (1/8" for size 1, 1/4" for size 2) that can be used for pressure gauges®, pressure switches® or, given the high flow rate, as additional air take-off®. These ports are downstream of the element, so, for example, a regulator port can supply air at a set pressure or a filter port can supply filtered air (not valid for activated carbon filter and depurator).

Wall fixing. Only two through screws® are needed. No bulky brackets or additional flanges are required. The bracket® can be used to separate the unit from the fixing wall, e.g. to mount a fitting to the rear port.

Fixing on a DIN EN50022 bar. Can be done using the bracket kit®.

Regulator fixing bracket®. Regulators and filter-regulators can also be fixed using a steel bracket® that embraces the bell.

Padlockable knob®. The knobs of regulators, filter-regulator and sectioning valves can all be padlocked. The steel plate is included in the supply. You can insert up to two 3 mm diameter padlocks® on size 1 and three padlocks on size 2. As an alternative, the sectioning valve can have a steel plate suitable for a single 6 mm diameter padlock.

Safety valve®. The unit can incorporate a series 70 SAFE AIR® safety valve.

Flowmeter series FLUX 1-2®. The unit can incorporate a series FLUX 1 or FLUX 2 flow meter.

C1

SYNTESI® KEY TO CODES

KEY TO CODES SINGLE ELEMENT

56	1	1	F	10	1
SYNTESI	SIZE	THREADED INPUT CONNECTION	ELEMENT	TYPE	THREADED OUTPUT CONNECTION
56 Syntesi 5X Syntesi anti-corrosion	1 Size 1 2 Size 2	0 Without bushing 1 1/8" port 2 1/4" port 3 3/8" port 0 Without bushing 3 3/8" port 4 1/2" port 5 3/4" port 6 1" port	F Filter D Depurator C Active carbon filter R Pressure regulator B Filter-regulator L Lubricator ● V Shut off valve ▲ A Progressive starter ▲ S Pressure switches P Air take-off	Varies from element to element	0 Without bushing 1 1/8" port 2 1/4" port 3 3/8" port 0 Without bushing 3 3/8" port 4 1/2" port 5 3/4" port 6 1" port

- The anti-corrosion version of this element is only available with manual actuation.
- ▲ Not available in the anti-corrosion version.

KEY TO CODES UNIT COMPOSED OF TWO OR THREE ELEMENTS

56	1	1	V	10	B	24	L	10	1
SYNTESI	SIZE	THREADED INPUT CONNECTION	ELEMENT 1	TYPE	ELEMENT 2	TYPE	ELEMENT 3	TYPE	THREADED OUTPUT CONNECTION
56 Syntesi 5X Syntesi anti-corrosion	1 Size 1 2 Size 2	1 1/8" port 2 1/4" port 3 3/8" port 3 3/8" port 4 1/2" port 5 3/4" port 6 1" port	F Filter D Depurator C Active carbon filter R Pressure regulator B Filter-regulator L Lubricator ● V Shut off valve ▲ A Progressive starter ▲ S Pressure switches P Air Take-off	Varies from element to element	F Filter D Depurator C Active carbon filter R Pressure regulator B Filter-regulator L Lubricator ● V Shut off valve ▲ A Progressive starter ▲ S Pressure switches P Air Take-off	Varies from element to element	F Filter D Depurator C Active carbon filter R Pressure regulator B Filter-regulator L Lubricator ● V Shut off valve ▲ A Progressive starter ▲ S Pressure switches P Air Take-off	Varies from element to element	1 1/8" port 2 1/4" port 3 3/8" port 3 3/8" port 4 1/2" port 5 3/4" port 6 1" port

- The anti-corrosion version of this element is only available with manual actuation.
- ▲ Not available in the anti-corrosion version.

UNITS

SYNTESI® KEY TO CODES

C1.8

Accessories

	Art. No.	Type No.
Neck bracket, for size 2, and others	145469	9400701
Mounting bracket, size 2, standard and anti-corr.	145659	9200717X
Adapter for DIN rail, size 1 and size 2	145660	9200718X
Pressure gauge, G1/4 rear centric, 0-12 bar, Ø63mm	145474	9900101
Adapter for pressure gauges, G 1/4 ET, G 1/8 IT	145477	9210005
Connecting nipple kit, size 2	144696	9210010
Connecting element 90°, size 2	145503	9210019
Size adapter, size 1 - size 2, incl. 4 screws	145504	9210006
Assembly key for bowl, size 2	145506	9210050
Fastening screw, size 2	145508	9210031
Padlock	145509	9062401
Bowl, size 2, RA fully automated	145615	9210106
Bowl, size 2, SAC fully automated	145616	9210107
Filter element, size 2, 20 µm	145623	9210156
Filter element, size 2, 50 µm	145624	9210157
Valve poppet for filter regulator, size 2, 20 µm	145655	9210232
Valve poppet for filter regulator, size 2, 50 µm	145656	9210233

Spareparts

	Art. No.	Type No.
Bowl, size 2, RMSA semi-automated	145614	9210105
Filter element, size 2, 5 µm	145622	9210155
Spring, size 2, 0 - 12 bar	145640	9210198
Regulator cap (bell), size 2, 0 - 12 bar	145648	9210223
Threaded port bushing, size 2, G 3/8	144691	9210011
Valve poppet for filter regulator, size 2, 5 µm	145654	9210231