

Filter

»SYNTESI« series

PLUS

Art. No. 144578

Type No. 5625F505

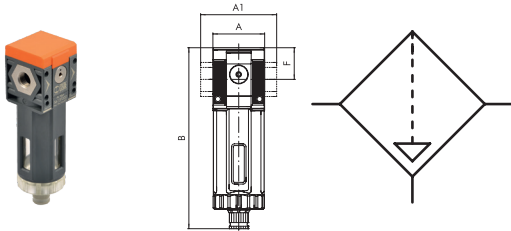

Exemplary illustration

Filtration takes place via a centrifugal separator (condensate) and a sintered filter element (solid particles). The condensate is maintained in a quiet state to prevent the deposited impurities from re-entering the circulation.

- Condensate drains RMSA semi-automatic or RA fully automatic. SAC fully automatic on request.
- Degree of filtration 20 µm (sufficient for most applications) or 5 µm. 50 µm on request.

The RA drain discharges condensate from the container automatically whenever necessary, regardless of the pressure level. The SAC tap drains the condensate only as the result of sudden changes in compressed air requests. On the front and back there is a port (G 1/8 for size 1 and G 1/4 for size 2) that can be used with pressure gauges, pressure switches or as an additional filtered air outlet.

Technical data

Series	Syntesi
Size	2
Max. input pressure	10 bar
Temperature range	-10 to 50 °C
Input	G 3/4
Output	G 3/4
Front and back port thread	G 1/4
Flow rate measurement 1	$P_2 = 6.3$ bar and pressure drop $\Delta_p = 0.5$ bar
Flow rate 1	3800 NI/min
Flow rate measurement 2	$P_2 = 6.3$ bar and pressure drop $\Delta_p = 1$ bar
Flow rate 2	5200 NI/min
Filter rating	20 μ m
Condensate drain	RA fully automatic
Output air purity class according to ISO 8573-1	4.7.4
Medium	Compressed air or other neutral gases
Housing	Technopolymer
Sealant	NBR
Bowl	Technopolymer
A	60.5 mm
A1	95.0 mm
B	182.0 mm
F	38.2 mm

Commercial data

Customs tariff number	84213925
Country of origin	IT
eCl@ss 5.1.4	27293005
eCl@ss 9.0	27293005
UNSPSC_Code_v190501	40161505
UNSPSC_CodeDesc_v190501	Air filters

SYNTESI[®] FILTER



The job of the filter is to retain liquid or solid impurities present in the compressed air. The incoming air is moved by the centrifuge unit, so that liquid particles, which are heavier, are projected against the walls of the container and force to adhere to it. As they accumulate, they create drops that deposit on the bottom by gravity. The remaining solid particles are held back by the porous filtering element. The condensate is maintained in a quiet state to prevent the deposited impurities from re-entering the circulation. The condensate drains out through the drain cock provided. The RMSA drain discharges when the pressure in the filter drops to zero. Alternatively the condensate can be drained by hand by pressing the button. The RA drain discharges condensate from the container automatically whenever necessary, regardless of the pressure level. The SAC tap drains the condensate only as the result of sudden changes in compressed air requests. On the front and back there is a port (1/8" for size 1 and 1/4" for size 2) that can be used with pressure gauges, pressure switches or as an additional filtered air intake.



TECHNICAL DATA	FIL SY1			FIL SY2			
	1/8"	1/4"	3/8"	3/8"	1/2"	3/4"	1"
Threaded port							
Degree of filtration	5 (yellow) - output air purity class ISO8573-1: 3.7.4 20 (white) - output air purity class ISO8573-1: 4.7.4 50 (blue) - output air purity class ISO8573-1: 5.7.4						
Max. input pressure	bar			bar			
	MPa			MPa			
	psi			psi			
Flow rate at 6.3 bar (0.63 MPa; 91 psi) ΔP 0.5 bar (0.05 MPa; 7 psi)	Nl/min	900	1200	1300	3400	3800	3800
	scfm	32	42	46	120	135	135
	Nl/min	1300	1650	1750	4500	5200	5200
Flow rate at 6.3 bar (0.63 MPa; 91 psi) ΔP 1 bar (0.1 MPa; 14 psi)	Nl/min	46	58	62	159	184	184
	scfm						
Min/max temperature at 10 bar; 1 MPa; 145 psi	°C			°C			
Weight	g			g			
	178	173	164	488	461	457	445
Condensate drain	RMSA: drain with manual condensate discharge and automatic discharge at zero pressure						
	RA: automatic drain with condensate discharge, independent of pressure and flow rate.						
	Version conveys the draining by inserting the pipe having internal diameter 6 mm in the lower port.						
	SAC: automatic drain with condensate discharge. Operates by pressure drop – requires variable air take-offs. Note: the maximum input pressure for the RA version must not exceed 10 bar						
Fluid	Compressed air or other inert gases						
Condensate bowl capacity	cm ³			cm ³			
Mounting position	Vertical			Vertical			
Port for additional air take-off	1/8", front and rear			1/4", front and rear			
Additional air take-off flow rate at 6.3 bar (0.63 MPa; 91 psi) ΔP 1 bar (0.1 MPa; 14 psi)	Nl/min			Nl/min			
	scfm			scfm			

UNITS

Syntesi[®] FILTER

COMPONENTS

- ① Technopolymer filter body
- ② IN/OUT bushing made of OT58 nickel-plated brass or passivated aluminium for 3/4" - 1"
- ③ Technopolymer centrifuge
- ④ Sintered HDPE filter cartridge
- ⑤ Technopolymer screen
- ⑥ Drain (RMSA)
- ⑦ Technopolymer plate
- ⑧ NBR o-ring gaskets
- ⑨ Clear technopolymer bowl

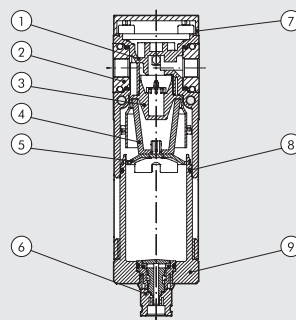

FLOW CHARTS

FIL Syntesi® SY1 1/8"

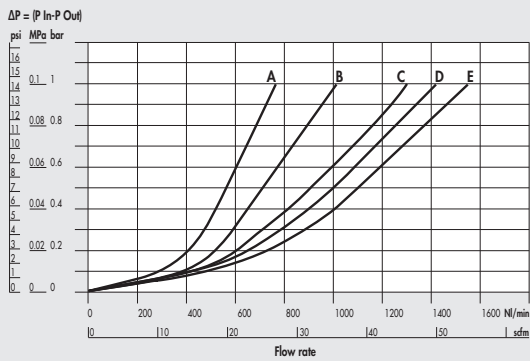

FIL Syntesi® SY1 1/4"

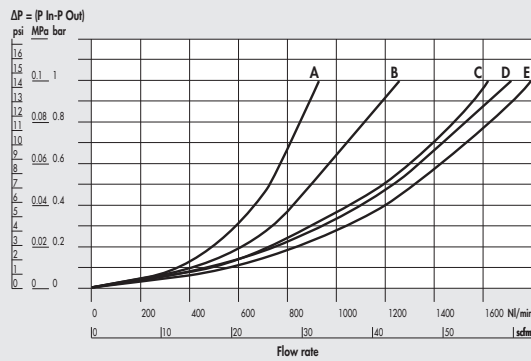

FIL Syntesi® SY1 3/8"

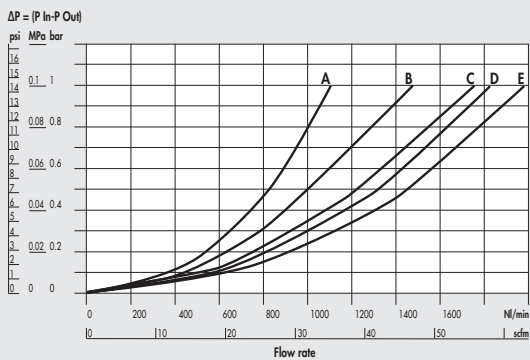

FIL Syntesi® SY2 3/8"

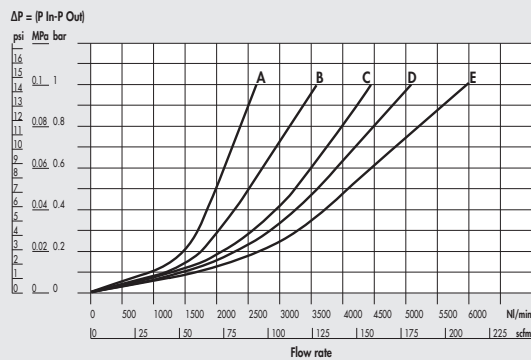

FIL Syntesi® SY2 1/2"

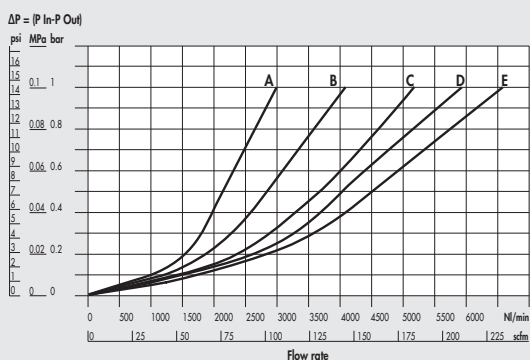

FIL Syntesi® SY2 3/4"-1"

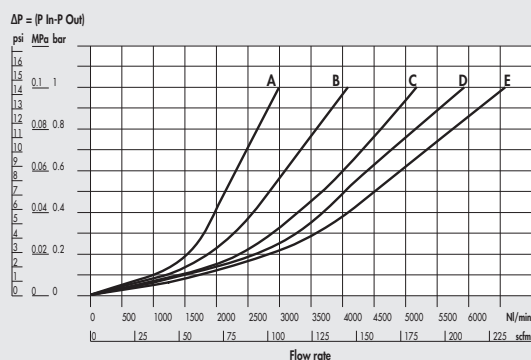

A = 2.5 bar - 0.25 MPa - 36 psi
B = 4 bar - 0.4 MPa - 58 psi

C = 6.3 bar - 0.63 MPa - 91 psi
D = 8 bar - 0.8 MPa - 116 psi

E = 10 bar - 1 MPa - 145 psi

UNITS

Syntesi® FILTER

DIMENSIONS

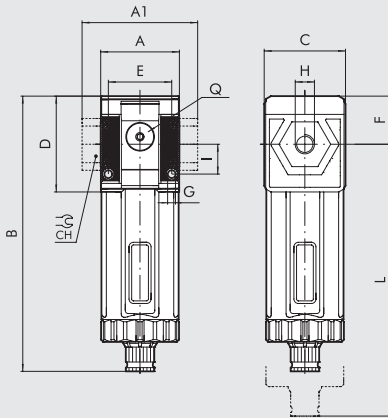

	SIZE 1			SIZE 2			
H (threaded port)	1/8"	1/4"	3/8"	3/8"	1/2"	3/4"	1"
A	42			60.5			
A1	-			44			
B	148			178			
	RMSA			152			
	RA/SAC			182			
C	44			61			
CH	-			32 36			
D	51.5			70.5			
E	33.5			47.5			
F	25.8			38.2			
G	Hole for M4 screws			Hole for M5 screws			
I	16			22.5			
L	202			245			
	RMSA			206			
	RA/SAC			249			
Q (no. 2 additional air takes-off)	1/8"			1/4"			

KEY TO CODES

56	1	1	F	10	1	
SYNTESI	SIZE	THREADED INPUT CONNECTION	ELEMENT	DEGREE OF FILTRATION AND TYPE OF CONDENSATE DRAIN	THREADED OUTPUT CONNECTION	
56 Syntesi 5X Syntesi anti-corrosion	1 Size 1	0 Without bushing 1 1/8" port 2 1/4" port 3 3/8" port	F Filter	10 5 µm, RMSA 20 20 µm, RMSA 30 50 µm, RMSA 40 5 µm, RA 50 20 µm, RA 60 50 µm, RA 11 5 µm, SAC 21 20 µm, SAC 31 50 µm, SAC	0 Without bushing 1 1/8" port 2 1/4" port 3 3/8" port	RMSA: drain with manual condensate discharge and automatic discharge at zero pressure. RA: automatic drain with condensate discharge, independent of pressure and flow rate. Version conveys the draining by inserting the pipe having internal diameter 6 mm in the lower port. SAC: automatic drain with condensate discharge. Operates by pressure drop - requires variable air take-offs.
	2 Size 2	0 Without bushing 3 3/8" port 4 1/2" port 5 3/4" port 6 1" port			0 Without bushing 3 3/8" port 4 1/2" port 5 3/4" port 6 1" port	

UNITS

Syntesi® FILTER

PURCHASE ORDER CODES HAVING A MORE FREQUENT USE

N.B. Besides the below mentioned codes, you can order elements composed at your will according to the key to codes.

Code	Description	Code	Description	Code	Description
Syntesi SY1 FILTER		Syntesi SY2 FILTER		Syntesi SY2 FILTER	
5610F100	FIL SY1 5 RMSA without bushings	5620F100	FIL SY2 5 RMSA without bushings	5626F106	FIL SY2 1 5 RMSA
5610F200	FIL SY1 20 RMSA without bushings	5620F200	FIL SY2 20 RMSA without bushings	5626F206	FIL SY2 1 20 RMSA
5610F400	FIL SY1 5 RA without bushings	5620F400	FIL SY2 5 RA without bushings	5626F406	FIL SY2 1 5 RA
5610F500	FIL SY1 20 RA without bushings	5620F500	FIL SY2 20 RA without bushings	5626F506	FIL SY2 1 20 RA
5611F101	FIL SY1 1/8 5 RMSA	5623F103	FIL SY2 3/8 5 RMSA		
5611F201	FIL SY1 1/8 20 RMSA	5623F203	FIL SY2 3/8 20 RMSA		
5611F401	FIL SY1 1/8 5 RA	5623F403	FIL SY2 3/8 5 RA		
5611F501	FIL SY1 1/8 20 RA	5623F503	FIL SY2 3/8 20 RA		
5612F102	FIL SY1 1/4 5 RMSA	5624F104	FIL SY2 1/2 5 RMSA		
5612F202	FIL SY1 1/4 20 RMSA	5624F204	FIL SY2 1/2 20 RMSA		
5612F402	FIL SY1 1/4 5 RA	5624F404	FIL SY2 1/2 5 RA		
5612F502	FIL SY1 1/4 20 RA	5624F504	FIL SY2 1/2 20 RA		
5613F103	FIL SY1 3/8 5 RMSA	5625F105	FIL SY2 3/4 5 RMSA		
5613F203	FIL SY1 3/8 20 RMSA	5625F205	FIL SY2 3/4 20 RMSA		
5613F403	FIL SY1 3/8 5 RA	5625F405	FIL SY2 3/4 5 RA		
5613F503	FIL SY1 3/8 20 RA	5625F505	FIL SY2 3/4 20 RA		

NOTE

Anti-corrosion version

5X_____

Example

5X11F101 FIL SY1 1/8 5 RMSA anti-corrosion

GENERAL TECHNICAL DATA SYNTESI®

Syntesi® is an important milestone achieved by Metal Work, the result of thirty years' experience producing air-treatment units. It has been studied in minute detail to obtain the best possible performance in a reduced space and with limited weight. The capacity is much higher than that of other units of the same size.

This modular unit features a very simple yet effective system that requires no brackets, stay bolts or yoke for assembling the elements.

The basic version of Syntesi® incorporates numerous functions that are not provided or are only optional with traditional units. Examples are padlockable knobs, additional pneumatic ports on the front and back, flow options from left to right or vice versa, regulators with compensation system - which are accurate even when the upstream pressure changes, with rapid downstream pressure relief - full indelible marking, automatic condensate drain even in size 1, and 360° visual inspection of oil and condensate levels. The basic materials, technopolymer and nickel-plated brass have excellent corrosion resistance. An anti-corrosion version is available with stainless steel components (screws, plates) or Geomet®-treated ones (regulator springs).



UNITS

GENERAL TECHNICAL DATA Syntesi®

TECHNICAL DATA	SIZE 1			SIZE 2			
	1/8"	1/4"	3/8"	3/8"	1/2"	3/4"	1"
Threaded port							
Max. input pressure	bar	15			13		
	MPa	1.5			1.3		
	psi	217			188		
Flow rate	See catalogue of the various elements						
Min/max temperature at 10 bar; 1 MPa; 145 psi	°C from -10 to +50			°C from -10 to +50			
Padlockable knob	The knobs of the regulators, filter regulators and standard sectioning valves can all be padlocked						
Fluid	Compressed air or other inert gases						
Mounting position	See catalogue of the various elements						
Direction of flow	Flow options right to left or vice versa						
Additional air take-off, for pressure gauges or fittings	1/8", front and rear, on all modules			1/4", front and rear, on all modules			
Wall fixing screws	No. 2 M4 screws			No. 2 M5 screws			
Certification for potentially explosive atmosphere according to ATEX 2014/34/EU rule	 II 3G Ex h IIC T5 Gc -10°C < Ta < 50°C II 3D Ex h IIIC T100 °C Dc						

ANTI-CORROSION VERSION

- Differences compared to the standard version:
- stainless steel screws
 - stainless steel plate for R, FR, V3V knobs
 - Geomet®-treated regulator spring and filter-regulator

FIXING TO FRONT PORTS



Do not use a spanner for fixing taper threaded elements to the front ports. Mount by hand and apply a liquid sealant (not teflon®).

ROTARY BUSHINGS



3/4" and 1" bushings in Size 2 rotate freely to facilitate assembly operations.

LASER MARKING



The following is marked indelibly on the body:

- Metal Work trademark
- Code
- Maximum pressure and temperature
- Degree of filtration or pressure range, where relevant
- Week and year of manufacture
- ATEX category
- Made in Italy

MOUNTING OPTIONS

On the wall, using two screws



On a panel



Using knob bracket



Using a bracket



The bracket can be secured in any position, and the fittings can be mounted on the pressure gauge air intake at the back of the unit.

On a DIN EN50022 bar with the opposite adaptor



UNITS

GENERAL TECHNICAL DATA Synthesi®

MODULARITY AND FLEXIBILITY

UNITS

GENERAL TECHNICAL DATA Syntesi®



The various elements of Syntesi® A can be connected to the air feed and delivery circuit using pneumatic nickel brass or passivated aluminium ports® and can be fixed together using nipples®.

The nipples and ports are easy to remove by unscrewing the two front screws®. This solution has numerous advantages:

- Reduced overall dimensions.
- Free composition of multiple elements, without the need for brackets, stay bolts or yoke.
- The threads for the fittings are metallic, allowing high tightening torques, also for tapered threads.
- Maximum flexibility: a unit can be transformed at any time by adding an element or replacing a port with another one, e.g. 1/4" instead of 1/8".
- The air intake port can be the same or different from the outlet port, as desired.

Standard Syntesi® ports are: 1/8", 1/4", 3/8" for size 1; 3/8", 1/2", 3/4", 1" for size 2.

It may be necessary to use a vice to insert the bushes into size 2.

The nipples have different functions:

- Nipple® joins two elements of the same size together.
- Size adaptor® can be used to connect an element in the Syntesi® 2 series with one in the Syntesi® 1 series.
- The 90° adaptor® can be used to connect two 90° angled elements. For example, it can help directing the regulator knob or the control knob of a sectioning valve towards the user.
- The two-way air intake® is a simple and cost-effective system which, besides connecting two elements together, has 2 opposing threaded air intakes.
- The adaptor for Regtronic® can be used to fix the Regtronic 1/4" proportional valve to a Syntesi® size 1 element.

Additional ports®. On the front and back of ALL Syntesi® elements there is a port (1/8" for size 1, 1/4" for size 2) that can be used for pressure gauges®, pressure switches® or, given the high flow rate, as additional air take-off®. These ports are downstream of the element, so, for example, a regulator port can supply air at a set pressure or a filter port can supply filtered air (not valid for activated carbon filter and depurator).

Wall fixing. Only two through screws® are needed. No bulky brackets or additional flanges are required. The bracket® can be used to separate the unit from the fixing wall, e.g. to mount a fitting to the rear port.

Fixing on a DIN EN50022 bar. Can be done using the bracket kit®.

Regulator fixing bracket®. Regulators and filter-regulators can also be fixed using a steel bracket® that embraces the bell.

Padlockable knob®. The knobs of regulators, filter-regulator and sectioning valves can all be padlocked. The steel plate is included in the supply. You can insert up to two 3 mm diameter padlocks® on size 1 and three padlocks on size 2. As an alternative, the sectioning valve can have a steel plate suitable for a single 6 mm diameter padlock.

Safety valve®. The unit can incorporate a series 70 SAFE AIR® safety valve.

Flowmeter series FLUX 1-2®. The unit can incorporate a series FLUX 1 or FLUX 2 flow meter.

C1

SYNTESI® KEY TO CODES

KEY TO CODES SINGLE ELEMENT

56	1	1	F	10	1
SYNTESI	SIZE	THREADED INPUT CONNECTION	ELEMENT	TYPE	THREADED OUTPUT CONNECTION
56 Syntesi 5X Syntesi anti-corrosion	1 Size 1 2 Size 2	0 Without bushing 1 1/8" port 2 1/4" port 3 3/8" port 0 Without bushing 3 3/8" port 4 1/2" port 5 3/4" port 6 1" port	F Filter D Depurator C Active carbon filter R Pressure regulator B Filter-regulator L Lubricator ● V Shut off valve ▲ A Progressive starter ▲ S Pressure switches P Air take-off	Varies from element to element	0 Without bushing 1 1/8" port 2 1/4" port 3 3/8" port 0 Without bushing 3 3/8" port 4 1/2" port 5 3/4" port 6 1" port

- The anti-corrosion version of this element is only available with manual actuation.
- ▲ Not available in the anti-corrosion version.

KEY TO CODES UNIT COMPOSED OF TWO OR THREE ELEMENTS

56	1	1	V	10	B	24	L	10	1
SYNTESI	SIZE	THREADED INPUT CONNECTION	ELEMENT 1	TYPE	ELEMENT 2	TYPE	ELEMENT 3	TYPE	THREADED OUTPUT CONNECTION
56 Syntesi 5X Syntesi anti-corrosion	1 Size 1 2 Size 2	1 1/8" port 2 1/4" port 3 3/8" port 3 3/8" port 4 1/2" port 5 3/4" port 6 1" port	F Filter D Depurator C Active carbon filter R Pressure regulator B Filter-regulator L Lubricator ● V Shut off valve ▲ A Progressive starter ▲ S Pressure switches P Air Take-off	Varies from element to element	F Filter D Depurator C Active carbon filter R Pressure regulator B Filter-regulator L Lubricator ● V Shut off valve ▲ A Progressive starter ▲ S Pressure switches P Air Take-off	Varies from element to element	F Filter D Depurator C Active carbon filter R Pressure regulator B Filter-regulator L Lubricator ● V Shut off valve ▲ A Progressive starter ▲ S Pressure switches P Air Take-off	Varies from element to element	1 1/8" port 2 1/4" port 3 3/8" port 3 3/8" port 4 1/2" port 5 3/4" port 6 1" port

- The anti-corrosion version of this element is only available with manual actuation.
- ▲ Not available in the anti-corrosion version.

UNITS

Syntesi® KEY TO CODES

C1.8

Accessories

	Art. No.	Type No.
Bowl, size 2, RMSA semi-automated	145614	9210105
Bowl, size 2, SAC fully automated	145616	9210107
Filter element, size 2, 5 µm	145622	9210155
Filter element, size 2, 50 µm	145624	9210157
Mounting bracket, size 2, standard and anti-corr.	145659	9200717X
Adapter for DIN rail, size 1 and size 2	145660	9200718X
Connecting nipple kit, size 2	144696	9210010
Connecting element 90°, size 2	145503	9210019
Size adapter, size 1 - size 2, incl. 4 screws	145504	9210006
Assembly key for bowl, size 2	145506	9210050
Fastening screw, size 2	145508	9210031

Spareparts

	Art. No.	Type No.
Automatic bleeder valve, RA	145609	9000802
Bowl, size 2, RA fully automated	145615	9210106
Filter element, size 2, 20 µm	145623	9210156
Threaded port bushing, size 2, G 3/4	144693	9210013