

Pressure regulator pilot-operated

»SYNTESI« series

PLUS ||

Art. No. 146053

Type No. 5610R000

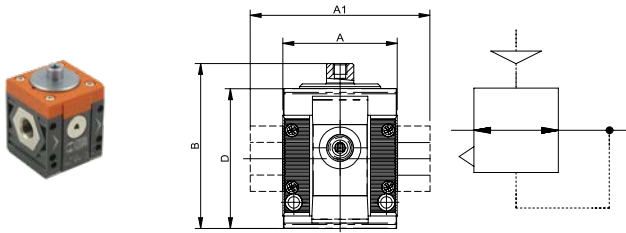

Exemplary illustration

The pilot operated regulator can adjust pressure remotely via a pneumatic command.

The two rolling diaphragms offer several advantages:

- Increased stroke, which allows greater opening of the valve and hence increased flow rate.
- Reduced dynamic and pickup friction, which results in increased response speed and high sensitivity.
- High precision in maintaining the set pressure, both with variable flow rates and different inlet pressures.

The design features the same construction characteristics as those used for a standard regulator, so the advantages are the same, namely:

- Compensation of the regulated pressure varies with the upstream pressure.
- Presence of a relieving valve and downstream pressure quick relieving.

ATEX version on request!

Technical data

Series	Syntesi
Size	1
Max. input pressure	15 bar
Temperature range	-10 to 50 °C
Input	without bushing
Output	without bushing
Front and back port thread	G 1/8
Flow rate measurement 1	at $P_1 = 10$ bar, $P_2 = 6.3$ bar and pressure drop $\Delta_p = 0.5$ bar
Flow rate 1	3300 NI/min
Flow rate measurement 2	at $P_1 = 10$ bar, $P_2 = 6.3$ bar and pressure drop $\Delta_p = 1$ bar
Flow rate 2	3550 NI/min
Medium	Compressed air or other neutral gases
Housing	Technopolymer
Sealant	NBR
Diaphragms	NBR 60 Shore (hardness) with polyester fabric insert
Pilot cap	Anodised aluminium plate
Pilot connection	M5
A	42.0 mm
A1	- mm
B	63.0 mm
D	51.5 mm

Commercial data

Customs tariff number	84811099
Country of origin	IT
eCl@ss 5.1.4	37011108
eCl@ss 9.0	37011108
UNSPSC_Code_v190501	41112404
UNSPSC_CodeDesc_v190501	Pressure regulator

SYNTESI® PILOT OPERATED REGULATOR

The pilot operated regulator can adjust pressure remotely via a pneumatic command.

The two rolling diaphragms offer several advantages:

- increased stroke, which allows greater opening of the valve and hence increased flow rate;
- reduced dynamic and pickup friction, which results in increased response speed and high sensitivity;
- high precision in maintaining the set pressure, both with variable flow rates and different inlet pressures.

The design features the same construction characteristics as those used for a standard regulator, so the advantages are the same, namely: compensation of the regulated pressure varies with the upstream pressure; presence of a relieving valve and downstream pressure quick relieving.



UNITS

Syntesi® PILOT OPERATED REGULATOR

TECHNICAL DATA	REG SY1			REG SY2			
	1/8"	1/4"	3/8"	3/8"	1/2"	3/4"	1"
Threaded port							
Max. inlet pressure	bar	15			13		
	MPa	1.5			1.3		
	psi	217			188		
Flow rate at 6.3 bar (0.63 MPa; 91 psi) ΔP 0.5 bar (0.05 MPa; 7 psi)	Nl/min	900	1700	3300	5500	5500	7300
(inlet pressure 10 bar)	scfm	32	60	116	194	194	258
Flow rate at 6.3 bar (0.63 MPa; 91 psi) ΔP 1 bar (0.1 MPa; 14 psi)	Nl/min	1000	2800	3550	6800	6800	7700
(inlet pressure 10 bar)	scfm	53	99	120	240	240	272
Relief valve flow rate at 6.3 bar (0.63 MPa; 91 psi)	Nl/min	70				100	
	scfm	2.5				3.5	
Min/max temperature at 10 bar; 1 MPa; 145 psi	°C	From -10 to +50			From -10 to +50		
Full outflow with zero inlet pressure		Included					
Upstream pressure compensation		Included, via balanced valve					
Weight	g	149	144	135	456	429	425
Fluid		Compressed air or other inert gases					
Mounting position		In any position					
Additional air take-off, for pressure gauges or fittings		1/8", front and rear			1/4", front and rear		
Additional air take-off flow rate at 6.3 bar		500			1400		
(0.63 MPa; 91 psi) ΔP 1 bar (0.1 MPa; 14 psi)		18			50		
Wall fixing screws		No. 2 M4 screws			No. 2 M5 screws		
Notes on use		The pressure must always be set upwards.					

COMPONENTS

- ① Anodized aluminium plate
- ② Anodized aluminium diaphragm washer
- ③ Anodized aluminium upper cap
- ④ Technopolymer flange
- ⑤ Rolling diaphragm
- ⑥ IN/OUT bushing made of OT58 nickel-plated brass or passivated aluminium for 3/4" - 1"
- ⑦ Technopolymer regulator body
- ⑧ OT58 brass valve, with NBR vulcanized gasket
- ⑨ Stainless steel valve spring
- ⑩ Technopolymer rod
- ⑪ NBR o-ring gasket
- ⑫ Technopolymer plug

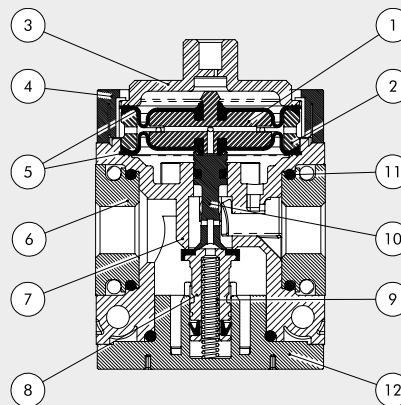

FLOW CHARTS

REG PIL Syntesi® SY1 1/8"

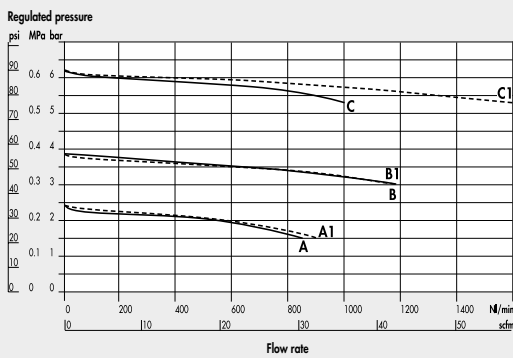

REG PIL Syntesi® SY1 1/4"

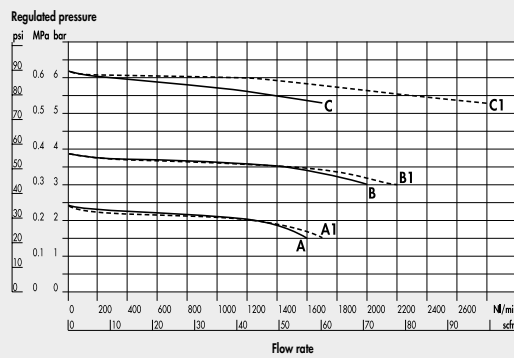

REG PIL Syntesi® SY1 3/8"

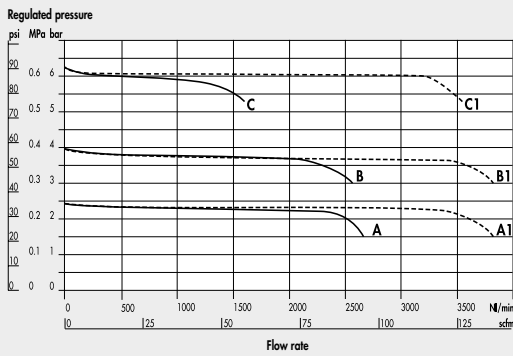

REG PIL Syntesi® SY2 3/8"

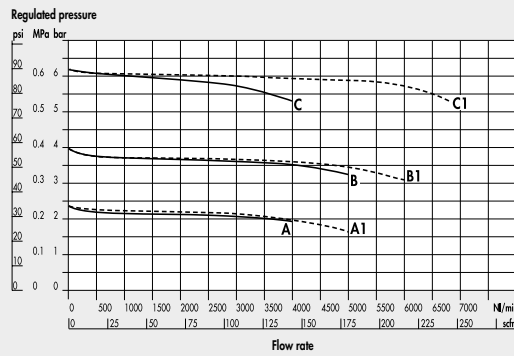

REG PIL Syntesi® SY2 1/2"

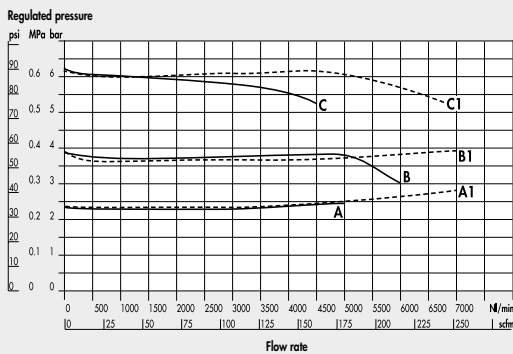

REG PIL Syntesi® SY2 3/4" - 1"

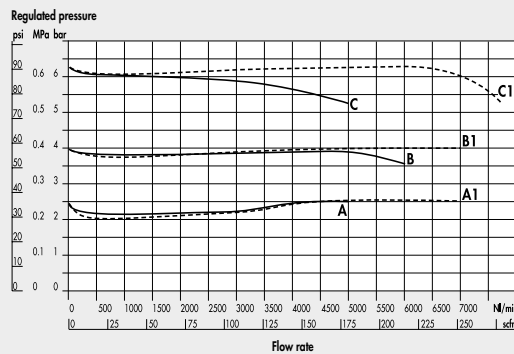

A = P In 7 bar - P Out 2.5 bar
 B = P In 7 bar - P Out 4 bar
 C = P In 7 bar - P Out 6.3 bar

A1 = P In 10 bar - P Out 2.5 bar
 B1 = P In 10 bar - P Out 4 bar
 C1 = P In 10 bar - P Out 6.3 bar

UNITS

Syntesi® PILOT OPERATED REGULATOR

PILOTING CURVES

REG PIL Syntesi® SY1

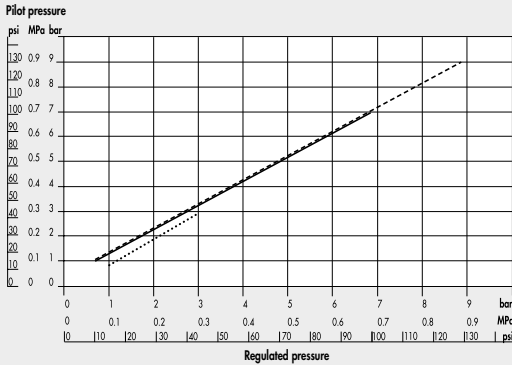

REG PIL Syntesi® SY2

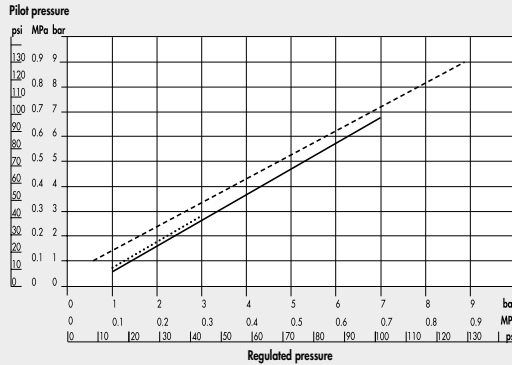

..... P In 4 bar

_____ P In 7 bar

----- P In 10 bar

DIMENSIONS

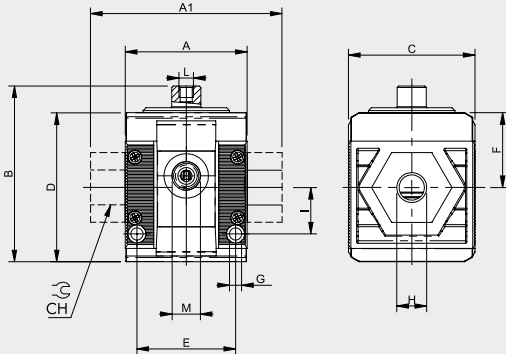

	SIZE 1			SIZE 2			
H (threaded port)	1/8"	1/4"	3/8"	3/8"	1/2"	3/4"	1"
A	42			60.5			
A1	-	-	44	-	-	95	95
B	63			81			
C	44			61			
CH	-			-	-	32	36
D	51.5			70.5			
E	33.5			47.5			
F	25.8			38.2			
G	Hole for M4 screws			Hole for M5 screws			
I	16			22.5			
L (pilot)	M5			M5			
M (pressure gauge port or air takes-off)	1/8"			1/4"			

KEY TO CODES

56	1	1	R	00	1
SYNTESI	SIZE	THREADED INPUT CONNECTION	ELEMENT	SETTING RANGE	THREADED OUTPUT CONNECTION
56 Syntesi 5X Syntesi anti-corrosion	1 Size 1 2 Size 2	0 Without bushing 1 1/8" port 2 1/4" port 3 3/8" port 0 Without bushing 3 3/8" port 4 1/2" port 5 3/4" port 6 1" port	R Pressure regulator	00 Pilot operated	0 Without bushing 1 1/8" port 2 1/4" port 3 3/8" port 0 Without bushing 3 3/8" port 4 1/2" port 5 3/4" port 6 1" port

UNITS

Syntesi® PILOT OPERATED REGULATOR

PURCHASE ORDER CODES HAVING A MORE FREQUENT USE

N.B. Besides the below mentioned codes, you can order elements composed at your will according to the key to codes.

Code	Description	Code	Description	NOTE
Syntesis SY1 PILOT OPERATED REGULATOR		Syntesis SY2 PILOT OPERATED REGULATOR		Anti-corrosion version
5610R000	REG PIL SY1 without bushings	5620R000	REG PIL SY2 without bushings	5X_-----
5611R001	REG PIL SY1 1/8	5623R003	REG PIL SY2 3/8	Example
5612R002	REG PIL SY1 1/4	5624R004	REG PIL SY2 1/2	5X11R001 REG PIL SY1 1/8 anti-corrosion
5613R003	REG PIL SY1 3/8	5625R005	REG PIL SY2 3/4	
		5626R006	REG PIL SY2 1	

NOTES
UNITS

Syntesis® PILOT OPERATED REGULATOR

GENERAL TECHNICAL DATA SYNTESI®

Syntesi® is an important milestone achieved by Metal Work, the result of thirty years' experience producing air-treatment units. It has been studied in minute detail to obtain the best possible performance in a reduced space and with limited weight. The capacity is much higher than that of other units of the same size.

This modular unit features a very simple yet effective system that requires no brackets, stay bolts or yoke for assembling the elements.

The basic version of Syntesi® incorporates numerous functions that are not provided or are only optional with traditional units. Examples are padlockable knobs, additional pneumatic ports on the front and back, flow options from left to right or vice versa, regulators with compensation system - which are accurate even when the upstream pressure changes, with rapid downstream pressure relief - full indelible marking, automatic condensate drain even in size 1, and 360° visual inspection of oil and condensate levels. The basic materials, technopolymer and nickel-plated brass have excellent corrosion resistance. An anti-corrosion version is available with stainless steel components (screws, plates) or Geomet®-treated ones (regulator springs).



UNITS

GENERAL TECHNICAL DATA Syntesi®

TECHNICAL DATA	SIZE 1			SIZE 2			
	1/8"	1/4"	3/8"	3/8"	1/2"	3/4"	1"
Threaded port							
Max. input pressure		15			13		
		MPa			1.3		
		psi			188		
Flow rate	See catalogue of the various elements						
Min/max temperature at 10 bar; 1 MPa; 145 psi	from -10 to +50			from -10 to +50			
Padlockable knob	The knobs of the regulators, filter regulators and standard sectioning valves can all be padlocked						
Fluid	Compressed air or other inert gases						
Mounting position	See catalogue of the various elements						
Direction of flow	Flow options right to left or vice versa						
Additional air take-off, for pressure gauges or fittings	1/8", front and rear, on all modules			1/4", front and rear, on all modules			
Wall fixing screws	No. 2 M4 screws			No. 2 M5 screws			
Certification for potentially explosive atmosphere according to ATEX 2014/34/EU rule	 II 3G Ex h IIC T5 Gc -10°C < Ta < 50°C II 3D Ex h IIIC T100 °C Dc						

ANTI-CORROSION VERSION

- Differences compared to the standard version:
- stainless steel screws
 - stainless steel plate for R, FR, V3V knobs
 - Geomet®-treated regulator spring and filter-regulator



FIXING TO FRONT PORTS

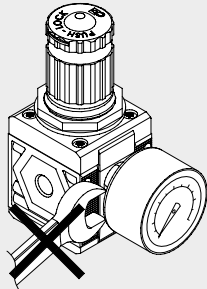

Do not use a spanner for fixing taper threaded elements to the front ports. Mount by hand and apply a liquid sealant (not teflon®).

ROTARY BUSHINGS

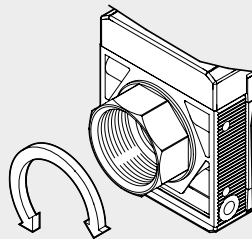

3/4" and 1" bushings in Size 2 rotate freely to facilitate assembly operations.

LASER MARKING

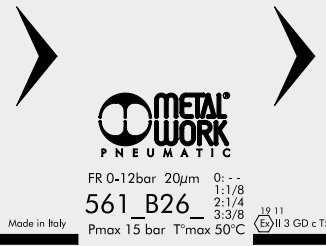

The following is marked indelibly on the body:

- Metal Work trademark
- Code
- Maximum pressure and temperature
- Degree of filtration or pressure range, where relevant
- Week and year of manufacture
- Atex category
- Made in Italy

MOUNTING OPTIONS

On the wall, using two screws

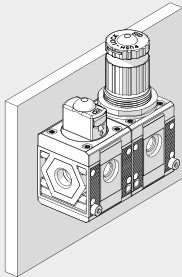

On a panel

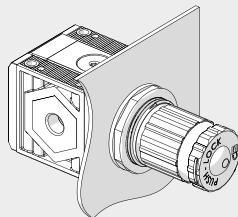

Using knob bracket

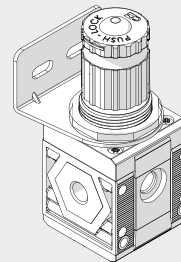

Using a bracket

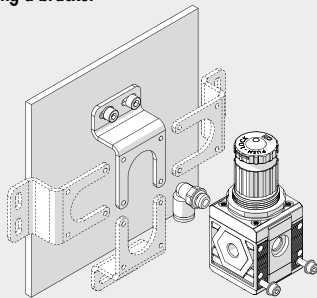

The bracket can be secured in any position, and the fittings can be mounted on the pressure gauge air intake at the back of the unit.

On a DIN EN50022 bar with the opposite adaptor

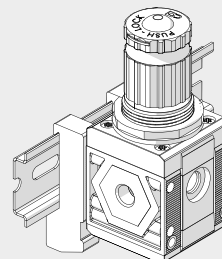

UNITS

GENERAL TECHNICAL DATA Synthesi®

MODULARITY AND FLEXIBILITY

UNITS

GENERAL TECHNICAL DATA Syntesi®

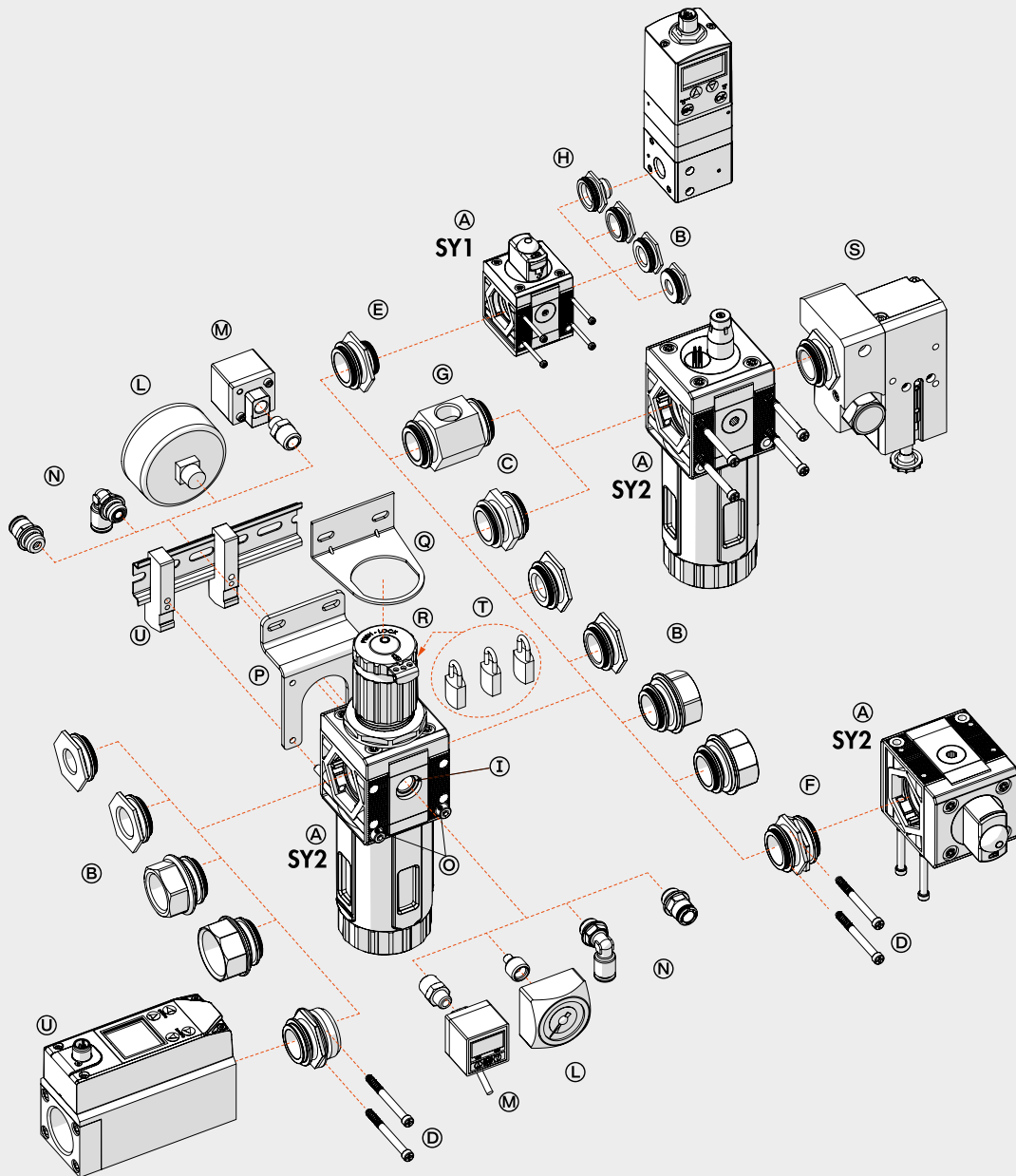

The various elements of Syntesi® ④ can be connected to the air feed and delivery circuit using pneumatic nickel brass or passivated aluminium ports ⑤ and can be fixed together using nipples ⑥.

The nipples and ports are easy to remove by unscrewing the two front screws ⑦. This solution has numerous advantages:

- Reduced overall dimensions.
- Free composition of multiple elements, without the need for brackets, stay bolts or yoke.
- The threads for the fittings are metallic, allowing high tightening torques, also for tapered threads.
- Maximum flexibility: a unit can be transformed at any time by adding an element or replacing a port with another one, e.g. 1/4" instead of 1/8".
- The air intake port can be the same or different from the outlet port, as desired.

Standard Syntesi® ports are: 1/8", 1/4", 3/8" for size 1; 3/8", 1/2", 3/4", 1" for size 2.

It may be necessary to use a vice to insert the bushes into size 2.

The nipples have different functions:

- Nipple ⑥ joins two elements of the same size together.
- Size adaptor ⑧ can be used to connect an element in the Syntesi® 2 series with one in the Syntesi® 1 series.
- The 90° adaptor ⑨ can be used to connect two 90° angled elements. For example, it can help directing the regulator knob or the control knob of a sectioning valve towards the user.
- The two-way air intake ⑩ is a simple and cost-effective system which, besides connecting two elements together, has 2 opposing threaded air intakes.
- The adaptor for Regtronic ⑪ can be used to fix the Regtronic 1/4" proportional valve to a Syntesi® size 1 element.

Additional ports ⑫. On the front and back of ALL Syntesi® elements there is a port (1/8" for size 1, 1/4" for size 2) that can be used for pressure gauges ⑬, pressure switches ⑭ or, given the high flow rate, as additional air take-off ⑮. These ports are downstream of the element, so, for example, a regulator port can supply air at a set pressure or a filter port can supply filtered air (not valid for activated carbon filter and depurator).

Wall fixing. Only two through screws ⑯ are needed. No bulky brackets or additional flanges are required. The bracket ⑰ can be used to separate the unit from the fixing wall, e.g. to mount a fitting to the rear port.

Fixing on a DIN EN50022 bar. Can be done using the bracket kit ⑱.

Regulator fixing bracket ⑲. Regulators and filter-regulators can also be fixed using a steel bracket ⑲ that embraces the bell.

Padlockable knob ⑳. The knobs of regulators, filter-regulator and sectioning valves can all be padlocked. The steel plate is included in the supply. You can insert up to two 3 mm diameter padlocks ㉑ on size 1 and three padlocks on size 2. As an alternative, the sectioning valve can have a steel plate suitable for a single 6 mm diameter padlock.

Safety valve ㉒. The unit can incorporate a series 70 SAFE AIR® safety valve.

Flowmeter series FLUX 1-2 ㉓. The unit can incorporate a series FLUX 1 or FLUX 2 flow meter.

C1

SYNTESI® KEY TO CODES

KEY TO CODES SINGLE ELEMENT

56	1	1	F	10	1
SYNTESI	SIZE	THREADED INPUT CONNECTION	ELEMENT	TYPE	THREADED OUTPUT CONNECTION
56 Syntesi 5X Syntesi anti-corrosion	1 Size 1 2 Size 2	0 Without bushing 1 1/8" port 2 1/4" port 3 3/8" port 0 Without bushing 3 3/8" port 4 1/2" port 5 3/4" port 6 1" port	F Filter D Depurator C Active carbon filter R Pressure regulator B Filter-regulator L Lubricator ● V Shut off valve ▲ A Progressive starter ▲ S Pressure switches P Air take-off	Varies from element to element	0 Without bushing 1 1/8" port 2 1/4" port 3 3/8" port 0 Without bushing 3 3/8" port 4 1/2" port 5 3/4" port 6 1" port

- The anti-corrosion version of this element is only available with manual actuation.
- ▲ Not available in the anti-corrosion version.

KEY TO CODES UNIT COMPOSED OF TWO OR THREE ELEMENTS

56	1	1	V	10	B	24	L	10	1
SYNTESI	SIZE	THREADED INPUT CONNECTION	ELEMENT 1	TYPE	ELEMENT 2	TYPE	ELEMENT 3	TYPE	THREADED OUTPUT CONNECTION
56 Syntesi 5X Syntesi anti-corrosion	1 Size 1 2 Size 2	1 1/8" port 2 1/4" port 3 3/8" port 3 3/8" port 4 1/2" port 5 3/4" port 6 1" port	F Filter D Depurator C Active carbon filter R Pressure regulator B Filter-regulator L Lubricator ● V Shut off valve ▲ A Progressive starter ▲ S Pressure switches P Air Take-off	Varies from element to element	F Filter D Depurator C Active carbon filter R Pressure regulator B Filter-regulator L Lubricator ● V Shut off valve ▲ A Progressive starter ▲ S Pressure switches P Air Take-off	Varies from element to element	F Filter D Depurator C Active carbon filter R Pressure regulator B Filter-regulator L Lubricator ● V Shut off valve ▲ A Progressive starter ▲ S Pressure switches P Air Take-off	Varies from element to element	1 1/8" port 2 1/4" port 3 3/8" port 3 3/8" port 4 1/2" port 5 3/4" port 6 1" port

- The anti-corrosion version of this element is only available with manual actuation.
- ▲ Not available in the anti-corrosion version.

UNITS

Syntesi® KEY TO CODES

C1.8

Accessories

	Art. No.	Type No.
Threaded port bushing, size 1, G 1/8	144688	9210001
Threaded port bushing, size 1, G 1/4,	144689	9210002
Threaded port bushing, size 1, G 3/8	144690	9210003
Connecting nipple kit, size 1	144695	9210000
Mounting bracket, size 1, standard and anti-corr.	145658	9200716X
Connecting element 90°, size 1	145502	9210009
Size adapter, size 1 - size 2, incl. 4 screws	145504	9210006
Fastening screw, size 1	145507	9210030
Adapter for DIN rail, size 1 and size 2	145660	9200718X

Spareparts

	Art. No.	Type No.
Locking screw, Hexagonal socket 3 mm, G 1/8, nickel-plated brass	111409	233.02-N