



Typical examples

3/2-5/2-5/3-way Electro-pneumatic

517 Series

Art. No. 106250 to 106591

G 1/8 DN 5	G 1/4 DN 7.5	G 3/8 DN 13.3	G 1/2 DN 15
---------------	-----------------	------------------	----------------

517 Series valves

Traditional pilot valve series. Suitable for **all** applications where **pneumatic** actuators have to be operated. These valves are designed for in-line installation, for mounting directly on the cylinder (with a special adapter) or as mass-produced valves with a multiple manifold base and an individual manifold base.

The following types are available:

- Four port sizes (1/8", 1/4", 3/8" and 1/2")
- Four types of operation (manual, mechanical, pneumatic or electro-pneumatic)
- 3/2, 5/2 and 5/3-way versions

Technical data

Designation	G 1/8	G 1/4	G 3/8	G 1/2
Max. working pressure range	10 bar			
Min. working pressure	2.5 bar			
- Monostable	1.0 bar			
- Bistable				
Medium temperature	-10 °C to +60 °C			
Ambient temperature*	-10 °C to +50 °C			
Nominal diameter (mm)	5	7.5	13.3	15
Conductance [NI/min – bar]	121.43	264.26	505.52	971.43
Flow rate / 6 bar - Δ 0.5 bar	400 NI/min	750 NI/min	1560 NI/min	3200 NI/min
Flow rate / 6 bar - Δ 1.0 bar	550 NI/min	1100 NI/min	2150 NI/min	4600 NI/min
TRA / TRR monostable at 6 bar**	15 ms / 35 ms	19 ms / 45 ms	21 ms / 72 ms	36 ms / 60 ms
TRA / TRR bistable at 6 bar**	20 ms / 20 ms	21 ms / 21 ms	18 ms / 18 ms	30 ms / 30 ms
Manual operator	Bistable			
Voltage	24 V/DC – 24 V/AC – 110 V/AC – 230 V/AC 50/60 Hz			
Electric power	2 W (DC) 3.5 VA (AC)			
Insulation class	F (max. self-heating of solenoid: 155 °C)			
Manual control	latching			

* Limited maximum ambient temperature due to the installed solenoid coil, whose proper function can only be guaranteed up to a maximum of +50 °C.
 ** TRA / TRR → on / off time for 95% pressure build-up referred to 6 bar

Materials

1	Valve body	Aluminium (surface hardened and tempered)
2	End stops	Hostaform
3	Piston	Aluminium (chemically nickel-plated)
4	Spacer	Plastic
5	Seals	NBR
6	Auxiliary piston	Hostaform
7	Seal	NBR
8	Filter	Sintered bronze
9	Spring	Special steel
10	Armature system	Brass sleeve / stainless steel

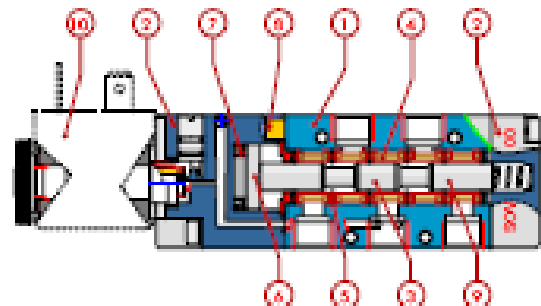



Selection table

Type No.	Art. No.	Port	U	DN	Function		Reset	Circuit diagram
					-way	Normal position		
517.101	106520	G 1/8	24 V DC	5	3/2	Monostable NO	Mechanical spring	
517.102	106521	G 1/4		7.5				
517.102-38	106522	G 3/8		13.3				
517.103	106523	G 1/2		15				
517.104	106524	G 1/8	230/50	5		Monostable NO		
517.105	106525	G 1/4		7.5				
517.105-38	106526	G 3/8		13.3				
517.106	106527	G 1/2		15				
517.111	106528	G 1/8	24 V DC	5		Monostable NC		
517.112	106529	G 1/4		7.5				
517.112-38	106530	G 3/8		13.3				
517.113	106531	G 1/2		15				
517.114	106532	G 1/8	230/50	5		Monostable NC		
517.115	106533	G 1/4		7.5				
517.115-38	106534	G 3/8		13.3				
517.116	106535	G 1/2		15				
517.121	106536	G 1/8	24 V DC	5	Bistable			
517.122	106537	G 1/4		7.5				
517.122-38	106538	G 3/8		13.3				
517.123	106539	G 1/2		15				
517.124	106540	G 1/8	230/50	5	Bistable			
517.125	106541	G 1/4		7.5				
517.125-38	106542	G 3/8		13.3				
517.126	106543	G 1/2		15				

Accessories

Manifold bases	Feed blocks	Connection plugs	Magnets
⇒ See	⇒ See	⇒ See	⇒ See
Sheet 15-G-1	Sheet 15-V-1	Sheet 15-Z-1	Sheet 15-Z-1



Selection table

Type No.	Art. No.	Port	U	DN	Function		Reset	Circuit diagram
					-way	Normal position		
517.201	106544	G 1/8	24 V DC	5	5/2	Monostable	Mechanical spring	
517.202	106545	G 1/4		7.5				
517.202-38	106546	G 3/8		13.3				
517.203	106547	G 1/2		15				
517.204	106548	G 1/8	230/50	5				
517.205	106549	G 1/4		7.5				
517.205-38	106550	G 3/8		13.3				
517.206	106551	G 1/2		15				
517.211	106552	G 1/8	24 V DC	5		5/2	Bistable	
517.212	106553	G 1/4		7.5				
517.212-38	106554	G 3/8		13.3				
517.213	106555	G 1/2		15				
517.214	106556	G 1/8	230/50	5				
517.215	106557	G 1/4		7.5				
517.215-38	106558	G 3/8		13.3				
517.216	106559	G 1/2		15				
517.221	106560	G 1/8	24 V DC	5	5/2		Differential piston Bistable	
517.222	106561	G 1/4		7.5				
517.222-38	106562	G 3/8		13.3				
517.223	106563	G 1/2		15				
517.224	106564	G 1/8	230/50	5				
517.225	106565	G 1/4		7.5				
517.225-38	106566	G 3/8		13.3				
517.226	106567	G 1/2		15				

Accessories

Manifold bases	Feed blocks	Connection plugs	Magnets
⇒ See	⇒ See	⇒ See	⇒ See
Sheet 15-G-1	Sheet 15-V-1	Sheet 15-Z-1	Sheet 15-Z-1

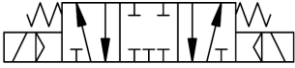
Selection table

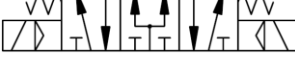
Type No.	Art. No.	Port	U	DN	Function		Circuit diagram	
					-way	Normal position		
517.301	106568	G 1/8	24 V DC	5	5/3	Mid-position <i>closed</i>		
517.302	106569	G 1/4		7.5				
517.302-38	106570	G 3/8		13.3				
517.303	106571	G 1/2		15				
517.304	106572	G 1/8	230/50	5				
517.305	106573	G 1/4		7.5				
517.305-38	106574	G 3/8		13.3				
517.306	106575	G 1/2		15				
517.311	106576	G 1/8	24 V DC	5		5/3	Mid-position <i>exhausted</i>	
517.312	106577	G 1/4		7.5				
517.312-38	106578	G 3/8		13.3				
517.313	106579	G 1/2		15				
517.314	106580	G 1/8	230/50	5				
517.315	106581	G 1/4		7.5				
517.315-38	106582	G 3/8		13.3				
517.316	106583	G 1/2		15				
517.321	106584	G 1/8	24 V DC	5	5/3		Mid-position <i>pressurised</i>	
517.322	106585	G 1/4		7.5				
517.322-38	106586	G 3/8		13.3				
517.323	106587	G 1/2		15				
517.324	106588	G 1/8	230/50	5				
517.325	106589	G 1/4		7.5				
517.325-38	106590	G 3/8		13.3				
517.326	106591	G 1/2		15				

Accessories

Manifold bases	Feed blocks	Connection plugs	Magnets
⇒ See	⇒ See	⇒ See	⇒ See
Sheet 15-G-1	Sheet 15-V-1	Sheet 15-Z-1	Sheet 15-Z-1

Dimensions

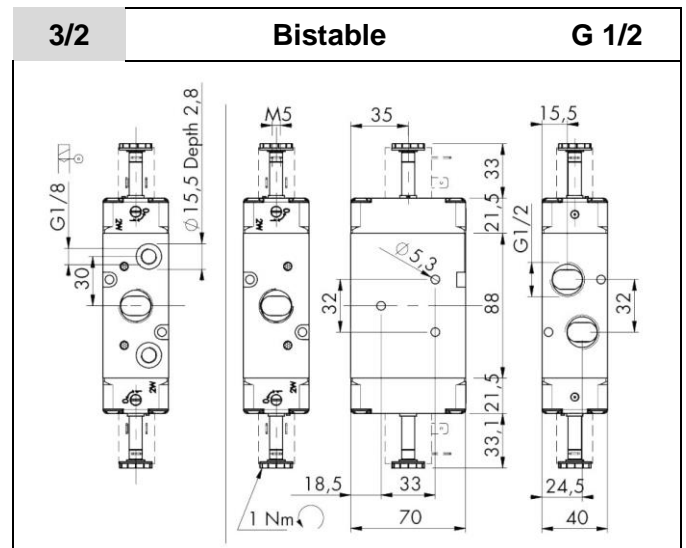
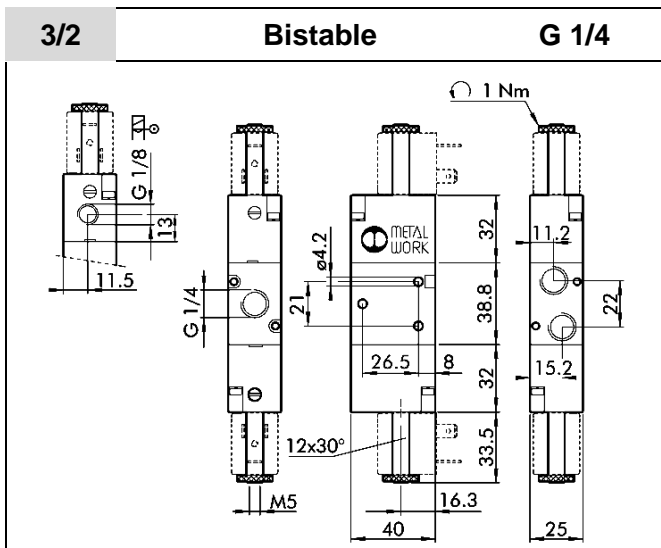
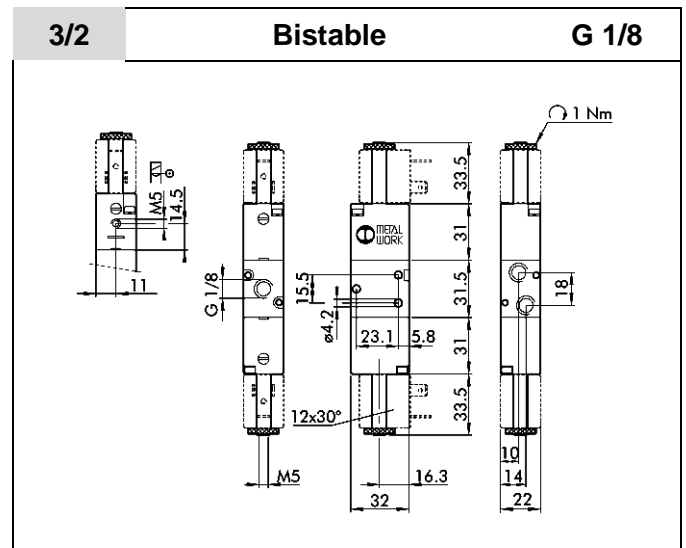
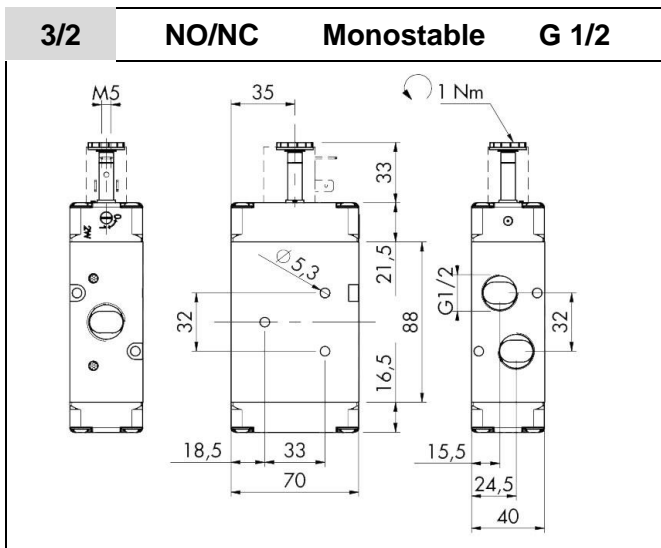
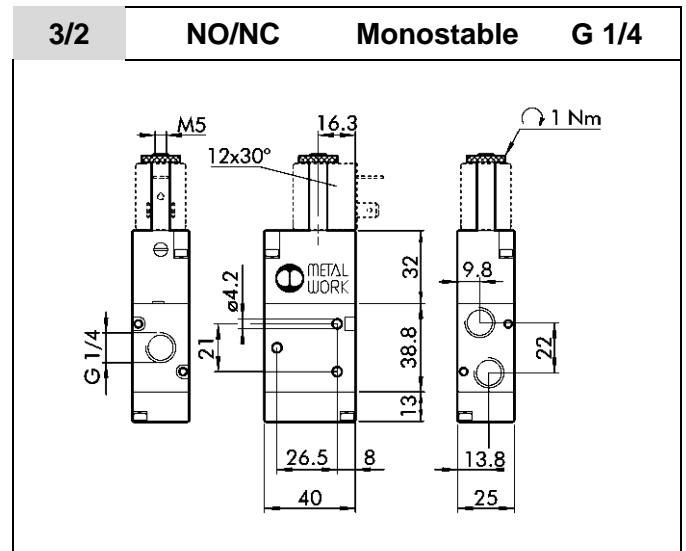
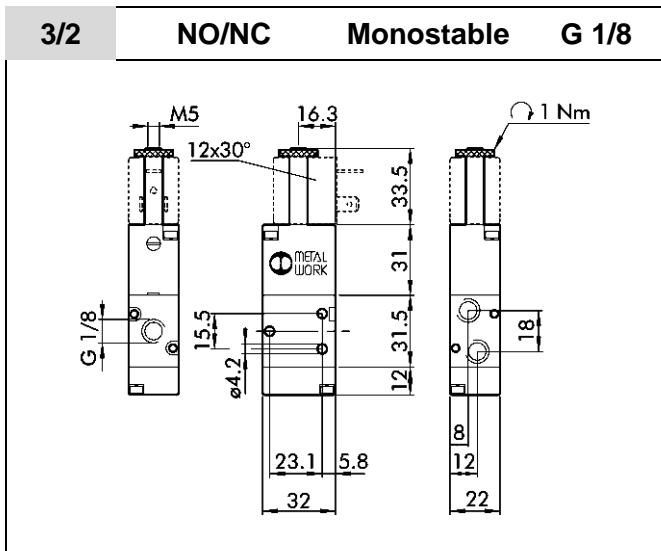

Dimensions

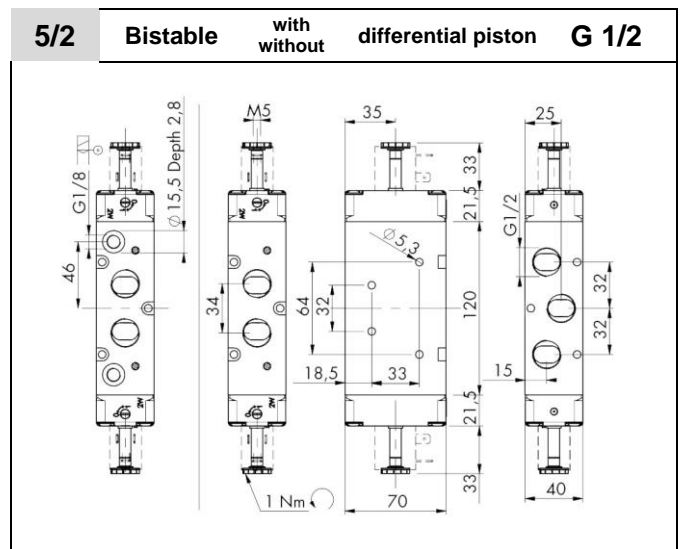
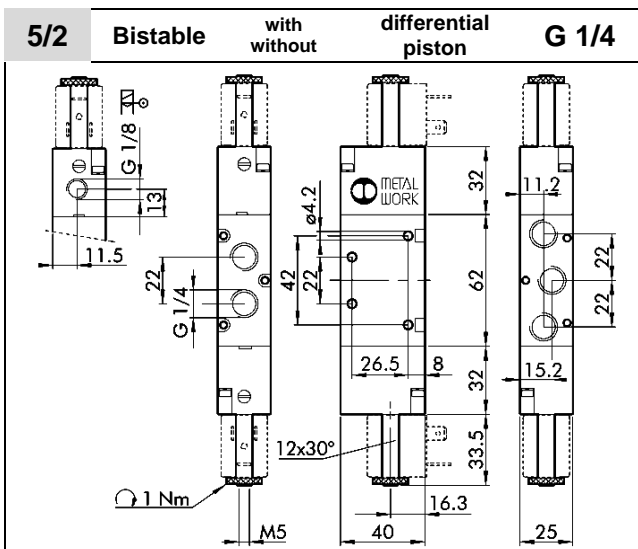
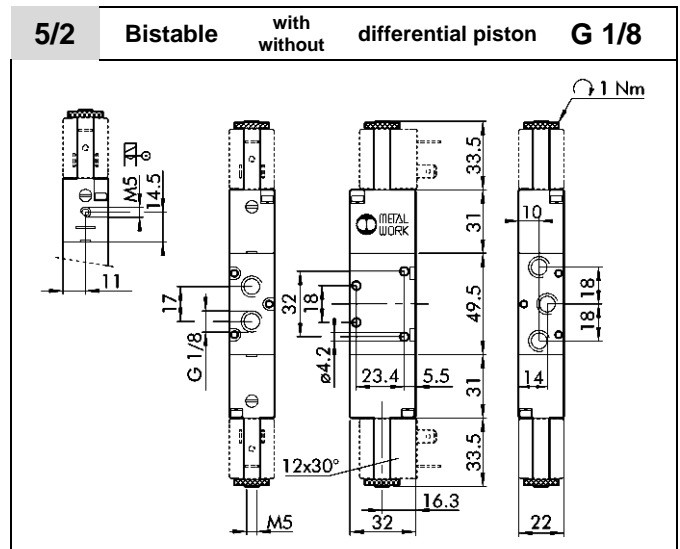
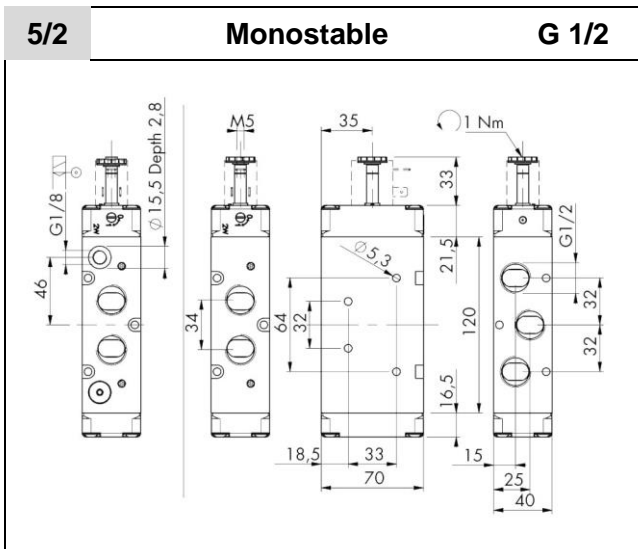
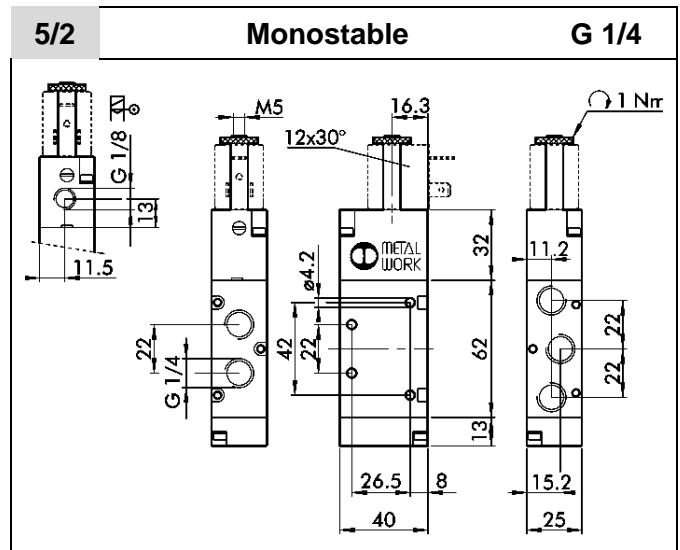
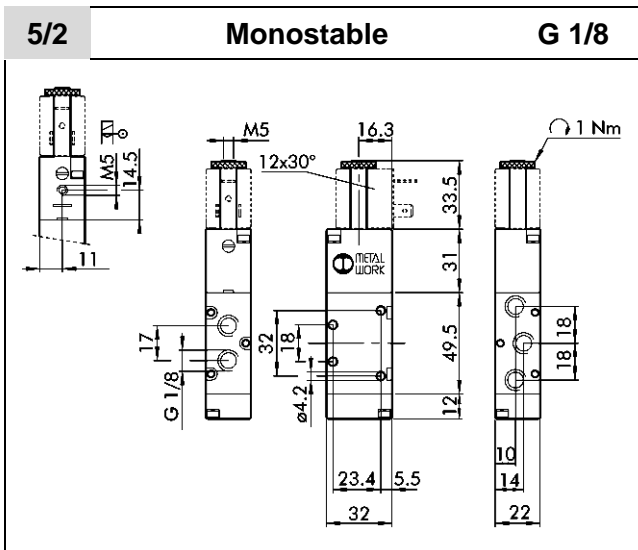

Dimensions

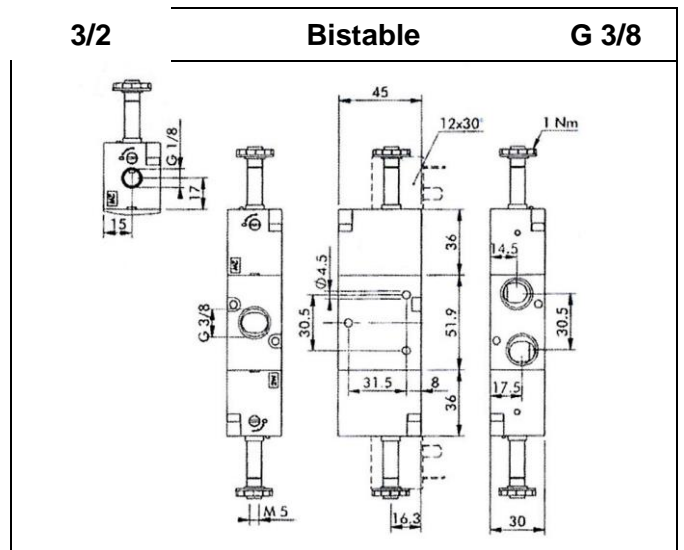
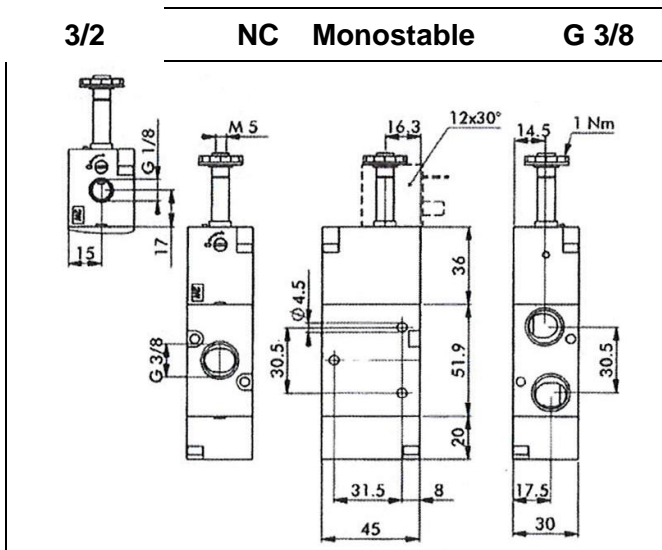
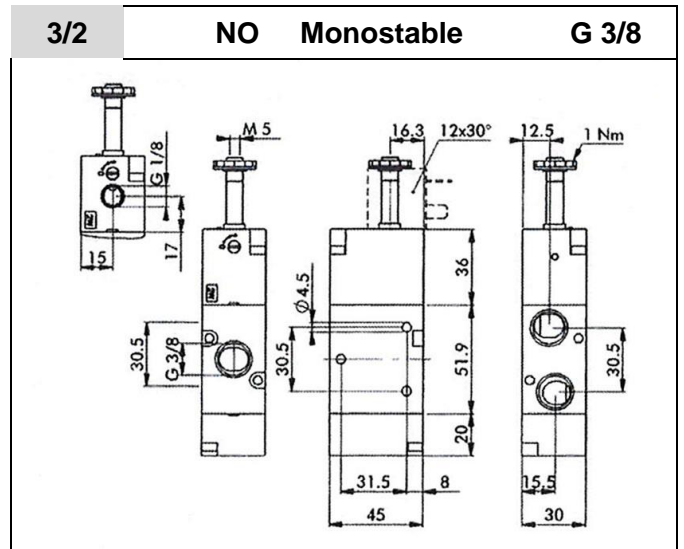
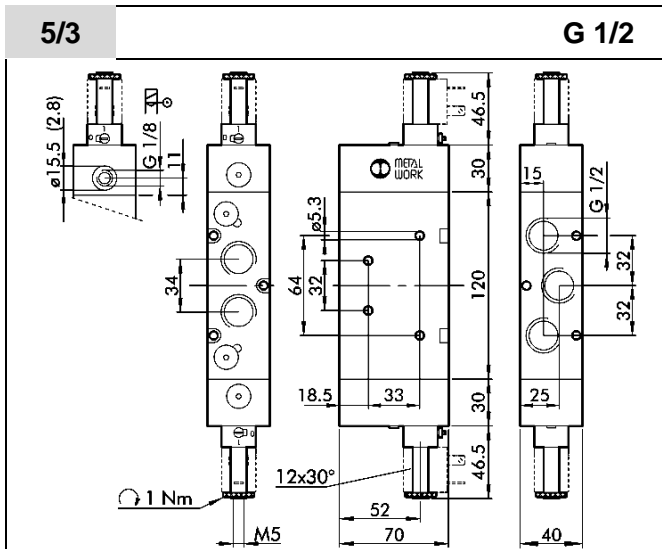
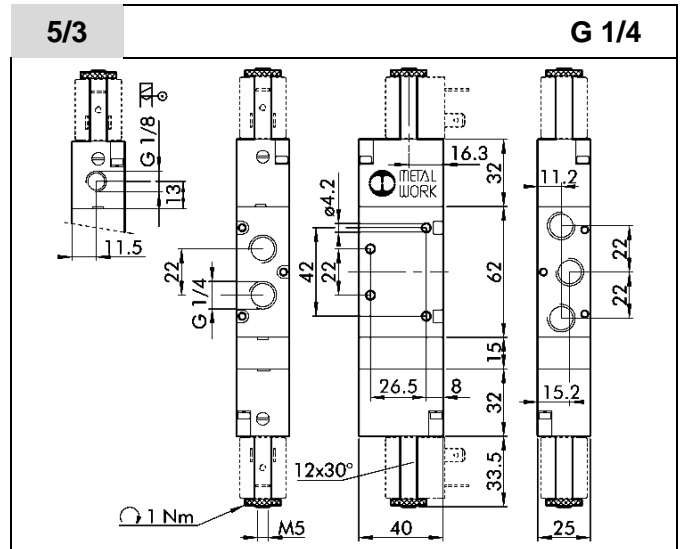
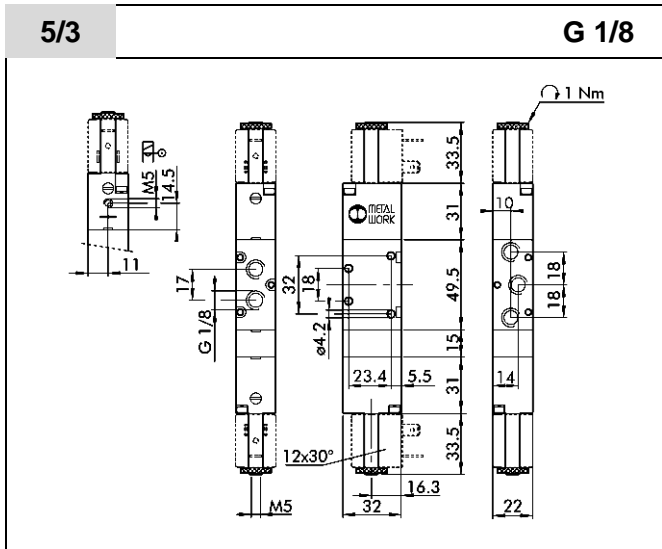

Dimensions

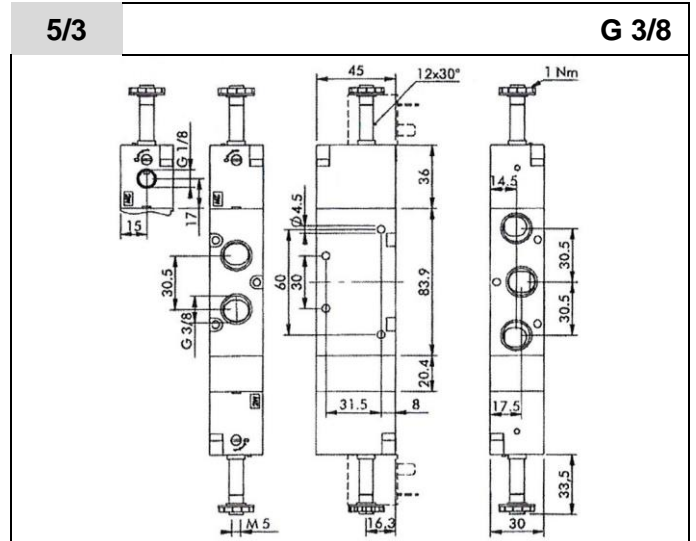
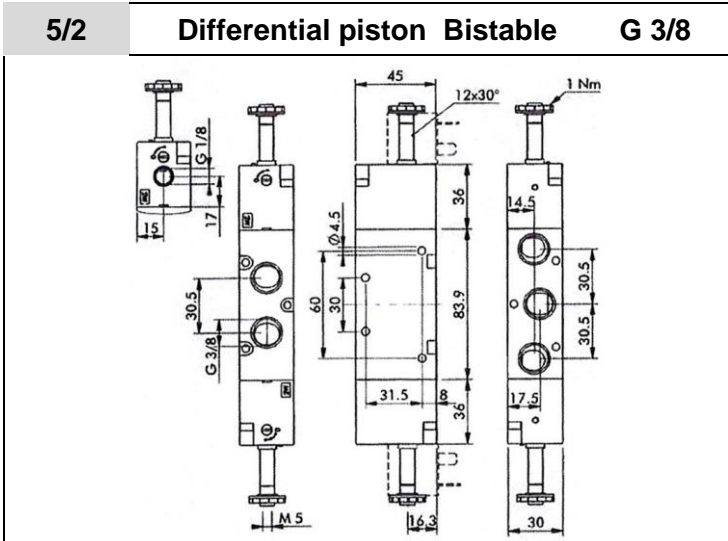
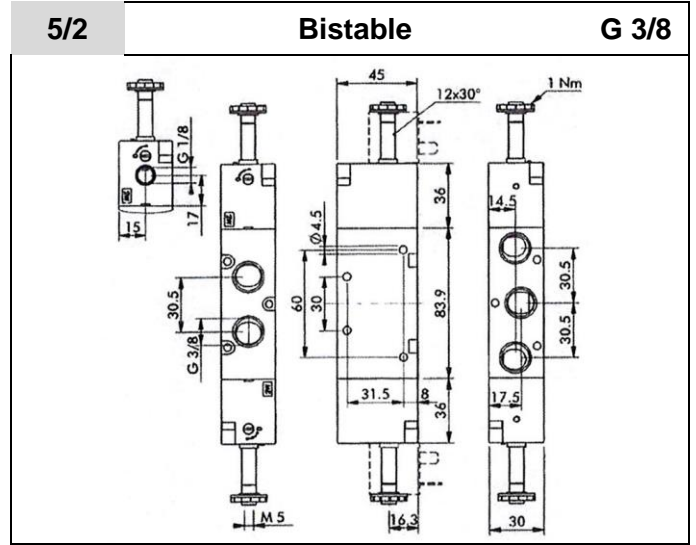
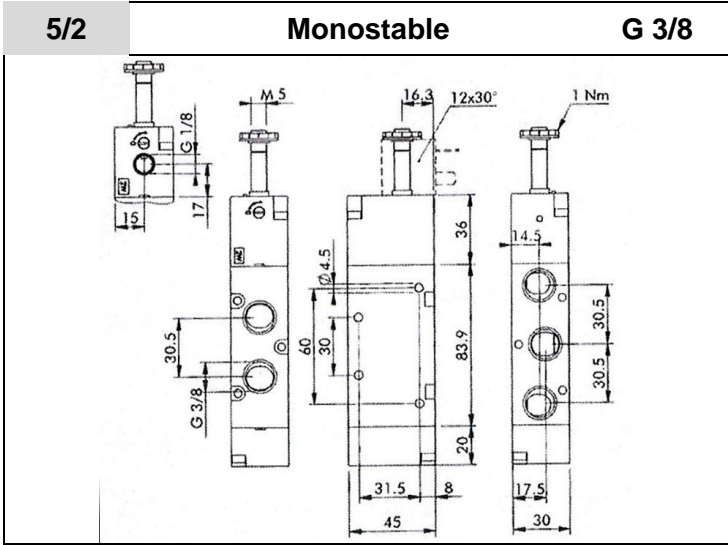



Exemplary illustration

Solenoid coil for control valves 517 series, width 22 mm

Art. No.	Type No.	Operating voltage	Electric power	
			Switch on	Hold on
118628	400-514-01	24V 50/60 Hz	5.3 VA	3.5 VA
118629	400-514-07	110V 50/60 Hz	5.3 VA	3.5 VA
118630	400-514-17	220V 50/60 Hz	5.3 VA	3.5 VA
118631	400-514-41	12Vcc	2 W	2 W
118632	400-514-42	24Vcc	2 W	2 W

Technical data – solenoid coil for control valves 517 series

Voltage tolerance	-10 / +15 %
Isolation class	F155
Protection class	IP65, DIN 40050 with socket
Note for use	Not suitable for longer use in free atmosphere
Coil temperature 100 % ED	55 °C at 20 °C ambient temperature
ATEX	According to ATEX 2014/34/EU directive, group II, category 3 GD

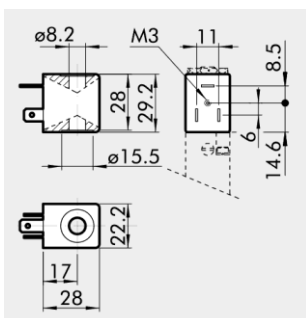
Dimensions:



Exemplary illustration

Solenoid coil for control valves 517 series, width 22 mm

Art. No.	Type No.	Operating voltage	Electric power	
			Switch on	Hold on
118633	400-517-01	24V 50/60 Hz	8 VA	5 VA
118634	400-517-07	110V 50/60 Hz	8 VA	5 VA
118635	400-517-17	220V 50/60 Hz	8 VA	5 VA
118636	400-517-41	12Vcc	5 W	5 W
118637	400-517-42	24Vcc	5 W	5 W

Technical data – solenoid coil for control valves 517 series

Voltage tolerance	-10 / +15 %
Isolation class	F155
Protection class	IP65, DIN 60529 with socket
Note for use	Not suitable for longer use in free atmosphere
Coil temperature 100 % ED	70 °C at 20 °C ambient temperature
ATEX	According to ATEX 2014/34/EU directive, group II, category 3 GD

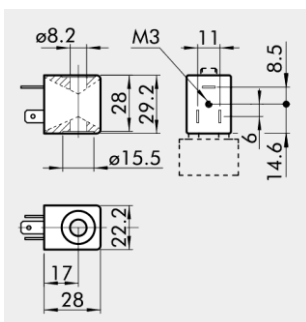
Dimensions:



Exemplary illustration

Plug connector for solenoid coils of control valves 517 series, width 22 mm

Art. No.	Type No.	Type	Colour	Ø cable
117313	1920.9P	Standard	Black	PG 9
117314	1920.9PL.17	LED 220 V	Transparent	PG 9
117316	1920.9PL.42	LED 24 V	Transparent	PG 9
117317	1920.9PLV17	LED + VDR 220 V	Transparent	PG 9
117318	1920.9PLV42	LED + VDR 24 V	Transparent	PG 9
151011	1920.9PL110	LED 110 V	Transparent	PG 9
123182	1920.9PL2GD-EX	ATEX II 2 GD	Black	PG 9
129849	1920.9PLV110	LED + VDR 110 V	Transparent	PG 9