

»MI and MSI« Series

11.DM.08010–11.DM.40600, 11.EM.08010–11.EM.40150

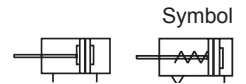

Product features

Round cylinders are available in the following versions:

- Double acting
- Single acting

Double acting, Ø 8–25, acc. to ISO 6432, with pivot-end, »CA« type

Double acting, Ø 32–40, with round-end, »CM« type

Single acting, Ø 8–25, with pivot-end, »CA« type

Single acting, Ø 32–40, with round-end, »CM« type

Specifications / Technical data

Piston-Ø [mm]	8	10	12	16	20	25	32	40
Acting type	Double acting / Single acting - Push type							
Fluid	Suitable for filtered, unlubricated or lubricated compressed air (to be filtered by 40 µm filter element). If lubrication is used, it must be continuous.							
Working Pressure	Double acting	1–10 bar (0.1 to 1.0 MPa; 14 to 145 psi)						
	Single acting	2–10 bar (0.2 to 1.0 MPa; 28 to 145 psi)						
Proof pressure	15 bar (1.5 MPa; 215 psi)							
Temperature range	-20 to 70 °C							
Speed range	Double-acting type: 30–800 mm/s; single-acting type: 50–800 mm/s							
Cushion type	Non adjustable / bumper							
Port size	M5x0.8				1/8"			1/4"

Stroke

Piston-Ø [mm]	Standard stroke	Max. stroke	Available stroke	
Double acting	8	10 / 15 / 20 / 25 / 30 / 40 / 50 / 60 / 75 / 80 / 100 / 125 / 150	150	200
	10	10 / 15 / 20 / 25 / 30 / 40 / 50 / 60 / 75 / 80 / 100 / 125 / 150 / 160 / 175 / 200	200	200
	12	10 / 15 / 20 / 25 / 30 / 40 / 50 / 60 / 75 / 80 / 100 / 125 / 150 / 160 / 175 / 200 / 250	250	500
	16	10 / 15 / 20 / 25 / 30 / 40 / 50 / 60 / 75 / 80 / 100 / 125 / 150 / 160 / 175 / 200 / 250 / 300	300	500
	20		500	700
	25	10 / 15 / 20 / 25 / 30 / 40 / 50 / 60 / 75 / 80 / 100 / 125 / 150 / 160 / 175 / 200 / 250 / 300 / 350 / 400 / 450 / 500 / 600	600	700
	32		600	700
	40		600	700
Single acting	8		-	-
	10	10 / 15 / 20 / 25 / 30 / 40 / 50	-	-
	12		-	-
	16	10 / 15 / 20 / 25 / 30 / 40 / 50 / 60 / 75 / 80 / 100	-	-
	20		-	-
	25		-	-
	32	10 / 15 / 20 / 25 / 30 / 40 / 50 / 60 / 75 / 80 / 100 / 125 / 150	-	-
	40		-	-

(Values in mm)

Remark: Contact us for non-standard stroke.

»MI and MSI« Series

11.DM.08010–11.DM.40600, 11.EM.08010–11.EM.40150

Ordering information »MI«, double-acting type

Type No.	Piston-Ø	Stroke	Connection	Piston rod male thread
11.DM.08010–08150	8	10–150	M5x0.8	M4x0.7
11.DM.10010–10200	10	10–200	M5x0.8	M4x0.7
11.DM.12010–12250	12	10–250	M5x0.8	M6x1.0
11.DM.16010–16300	16	10–300	M5x0.8	M6x1.0
11.DM.20010–20600	20	10–600	G 1/8	M8x1.25
11.DM.25010–25600	25	10–600	G 1/8	M10x1.25
11.DM.32010–32600	32	10–600	G 1/8	M10x1.25
11.DM.40010–40600	40	10–600	G 1/4	M12x1.25

(Values in mm)

Ordering information »MSI«, single-acting type

Type No.	Piston-Ø	Stroke	Connection	Piston rod male thread
11.EM.08010–08050	8	10–50	M5x0.8	M4x0.7
11.EM.10010–10050	10	10–50	M5x0.8	M4x0.7
11.EM.12010–12050	12	10–50	M5x0.8	M6x1.0
11.EM.16010–16100	16	10–100	M5x0.8	M6x1.0
11.EM.20010–20150	20	10–150	G 1/8	M8x1.25
11.EM.25010–25150	25	10–150	G 1/8	M10x1.25
11.EM.32010–32150	32	10–150	G 1/8	M10x1.25
11.EM.40010–40150	40	10–150	G 1/4	M12x1.25

(Values in mm)

»MI and MSI« Series

11.DM.08010–11.DM.40600, 11.EM.08010–11.EM.40150

Dimensions »MI«, double-acting type

Ø 8–25

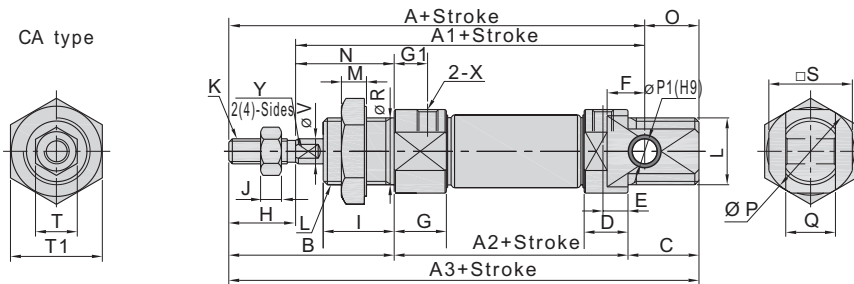

Ø 32–40

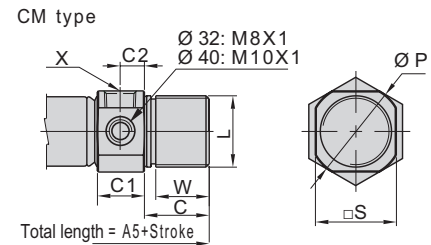

On request:

R type

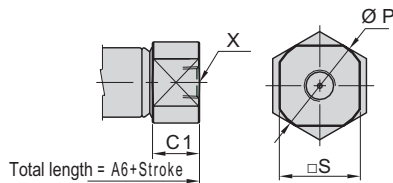

U type

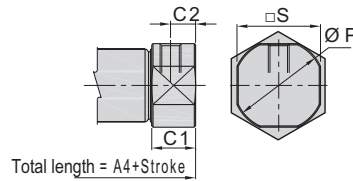

Piston-Ø	A	A1	A2	A3	A4	A5	A6	B	C	C1	C2	D	E	F	G	G1	H	I
8	76	64	46	86	74	-	-	28	12	9.5	5	9.5	5	6	11.5	7	12	12
10	76	64	46	86	74	-	-	28	12	9.5	5	9.5	5	6	11.5	7	12	12
12	91	75	50	105	88	-	-	38	17	10.5	6	10.5	6	9	12.5	8	16	17
16	98	82	56	111	94	111	94	38	17	10.5	6	10.5	6	9	12.5	8	16	17
20	115	95	62	126	106	126	106	44	20	14.5	7.5	14.5	7.5	12	14.5	7.5	20	20
25	126	104	65	137	114.5	137	115	50	22	16	8	16	8	12	16	8	22	22
32	-	-	-	-	125	140	126	58	14	16.5	9	-	-	-	16.5	9	20	30
40	-	-	-	-	158	174	158	69	16	22	12	-	-	-	22	12	24	35

Piston-Ø	J	K	L	M	N	O	P	P1	Q	R	S	T	T1	X	V	W	Y
8	2.5	M4x0.7	M12x1.25	6	16	10	17	4	8	12	15	7	17	M5x0.8	4	-	-
10	2.5	M4x0.7	M12x1.25	6	16	10	17	4	8	12	15	7	17	M5x0.8	4	-	-
12	5	M6x1.0	M16x1.5	6	22	14	20	6	12	16	18	10	22	M5x0.8	6	-	5
16	5	M6x1.0	M16x1.5	6	22	13	22	6	12	16	20	10	22	M5x0.8	6	13.5	5
20	6	M8x1.25	M22x1.5	7	24	11	29	8	16	22	25	12	29	1/8 ⁽¹⁾	8	16.5	6
25	6	M10x1.25	M22x1.5	7	28	11	33.5	8	16	22	30	17	29	1/8 ⁽¹⁾	10	18.5	8
32	6	M10x1.25	M30x1.5	7	38	-	37.5	-	-	30	34.5	17	36	1/8 ⁽¹⁾	12	10.5	10
40	7	M12x1.25	M38x1.5	8	45	-	46.5	-	-	38	42.5	17	46	1/4 ⁽¹⁾	16	12.5	14

(Values in mm, exception ¹⁾ = inch)

»MI and MSI« Series

11.DM.08010–11.DM.40600, 11.EM.08010–11.EM.40150

Dimensions »MSI«, single-acting type

Ø 8–25

Ø 32–40

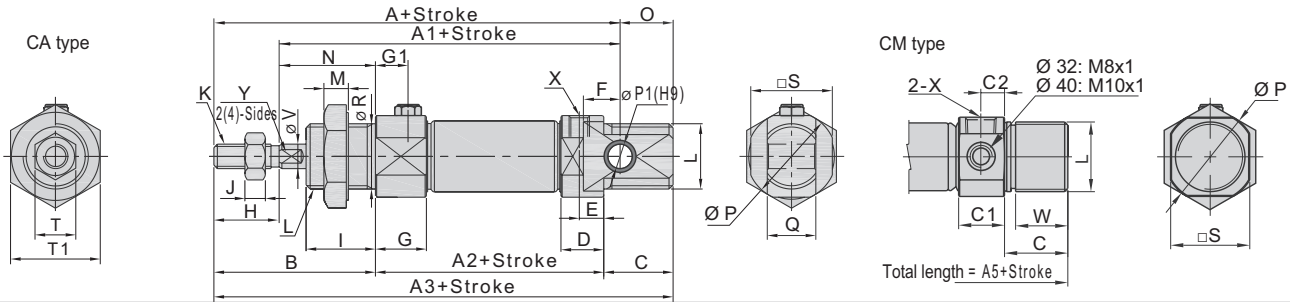

On request:

R type

U type

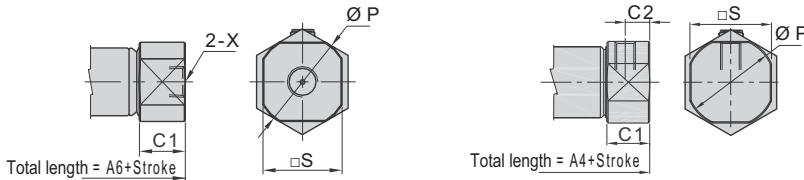

Stroke	A			A1			A2			A3		
	0–50	51–100	101–150	0–50	51–100	101–150	0–50	51–100	101–150	0–50	51–100	101–150
Piston-Ø												
8	101	-	-	89	-	-	71	-	-	111	-	-
10	101	-	-	89	-	-	71	-	-	111	-	-
12	116	-	-	100	-	-	75	-	-	130	-	-
16	123	148	-	107	132	-	81	106	-	136	161	-
20	140	165	190	120	145	170	87	112	137	151	176	201
25	151	176	201	129	154	179	90	115	140	162	187	212
32	-	-	-	-	-	-	-	-	-	-	-	-
40	-	-	-	-	-	-	-	-	-	-	-	-

(Values in mm)

Stroke	A4			A5			A6		
	0–50	51–100	101–150	0–50	51–100	101–150	0–50	51–100	101–150
Piston-Ø									
8	99	-	-	-	-	-	-	-	-
10	99	-	-	-	-	-	-	-	-
12	113	-	-	-	-	-	-	-	-
16	119	144	-	136	161	-	119	144	-
20	131	156	181	151	176	201	131	156	181
25	139.5	164.5	189.5	162	187	212	140	165	190
32	150	175	200	165	190	215	151	176	201
40	183	208	233	199	224	249	183	208	233

(Values in mm)

»MI and MSI« Series

11.DM.08010–11.DM.40600, 11.EM.08010–11.EM.40150

Dimensions »MSI«, single-acting type (cont.)

Piston-Ø	B	C	C1	C2	D	E	F	G	G1	H	I	J	K
8	28	12	9.5	5	9.5	5	6	11.5	7	12	12	2.5	M4x0.7
10	28	12	9.5	5	9.5	5	6	11.5	7	12	12	2.5	M4x0.7
12	38	17	10.5	6	10.5	6	9	12.5	8	16	17	5	M6x1.0
16	38	17	10.5	6	10.5	6	9	12.5	8	16	17	5	M6x1.0
20	44	20	14.5	7.5	14.5	7.5	12	14.5	7.5	20	20	6	M8x1.25
25	50	22	16	8	16	8	12	16	8	22	22	6	M10x1.25
32	58	14	16.5	9	-	-	-	16.5	9	20	30	6	M10x1.25
40	69	16	22	12	-	-	-	22	12	24	35	7	M12x1.25

(Values in mm)

Piston-Ø	L	M	N	O	P	P1	Q	R	S	T	T1	X	V	W	Y
8	M12x1.25	6	16	10	17	4	8	12	15	7	17	M5x0.8	4	-	-
10	M12x1.25	6	16	10	17	4	8	12	15	7	17	M5x0.8	4	-	-
12	M16x1.5	6	22	14	20	6	12	16	18	10	22	M5x0.8	6	-	5
16	M16x1.5	6	22	13	22	6	12	16	20	10	22	M5x0.8	6	13.5	5
20	M22x1.5	7	24	11	29	8	16	22	25	12	29	1/8" ¹⁾	8	16.5	6
25	M22x1.5	7	28	11	33.5	8	16	22	30	17	29	1/8" ¹⁾	10	18.5	8
32	M30x1.5	7	38	-	37.5	-	-	30	34.5	17	36	1/8" ¹⁾	12	10.5	10
40	M38x1.5	8	45	-	46.5	-	-	38	42.5	17	46	1/4" ¹⁾	16	12.5	14

(Values in mm, exception ¹⁾ = inch)

Components and materials

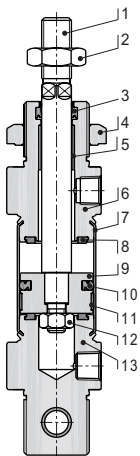

No.	Item	Material	
1	Rod	Stainless steel	
2	Rod nut	Carbon steel	
3	Front cover packing	NBR	
4	Front cover nut	Carbon steel	
5	Bushing	Ø 8–25	-
		Ø 32–40	Wear resistant material (bronze)
6	Front cover	Aluminum alloy	
7	Barrel	Stainless steel	
8	Bumper	TPU	
9	Piston	Ø 8–12	Stainless steel
		Ø 16–40	Aluminum alloy
10	Piston O-ring	NBR	
11	Wear ring	Wear resistant material	
12	Nut	Carbon steel	
13	Back cover	Aluminum alloy	

Accessories

Flange model, »FA« type 437.240–437.242



Type 437.241-1

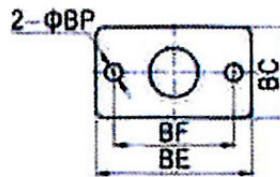
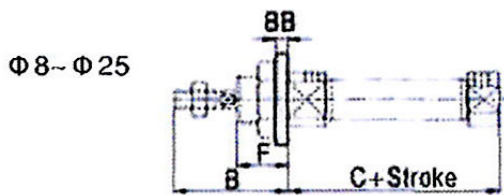

Dimensions and material

Type No.	Piston-Ø	B	C	BB	BC	BE	BF	BP	F	Material
437.240	8	28	46	3	22	40	30	4.5	12	Steel
	10	28	46	3	22	40	30	4.5	12	
437.241	12	38	50	4	30	52	40	5.5	17	
	16	38	56	4	30	52	40	5.5	17	
437.241-1	12	38	50	3	26	52	40	5.5	17	
	16	38	56	3	26	52	40	5.5	17	
437.242	20	44	62	5	40	66	50	6.6	20	
	25	50	65	5	40	66	50	6.6	22	
437.242-1	20	44	62	3.5	38	66	50	7.0	20	
	25	50	65	3.5	38	66	50	7.0	22	

(Values in mm)

For piston Ø 32–40 not available.

Hinge head model, »TC« type 437.230–437.234

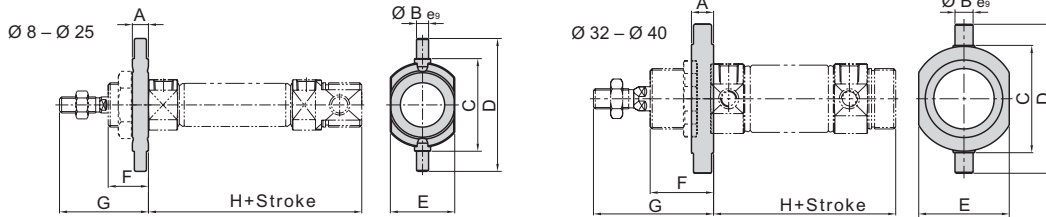

Dimensions and material

Type No.	Piston-Ø	A	B	C	D	E	F	G	H	Material
437.230	8	6	4	26	38	20	12	28	58	Stainless steel
	10	6	4	26	38	20	12	28	58	
437.231	12	8	6	38	58	25	17	38	67	
	16	8	6	38	58	25	17	38	73	
437.232	20	8	6	46	66	32	20	44	82	
	25	8	6	46	66	32	22	50	87	
437.233	32	11	9	54	74	45	30	58	82	
437.234	40	12	10	64	84	55	35	69	101	

(Values in mm)

Accessories

Counter hinge model, »SDB« type
437.250–437.254

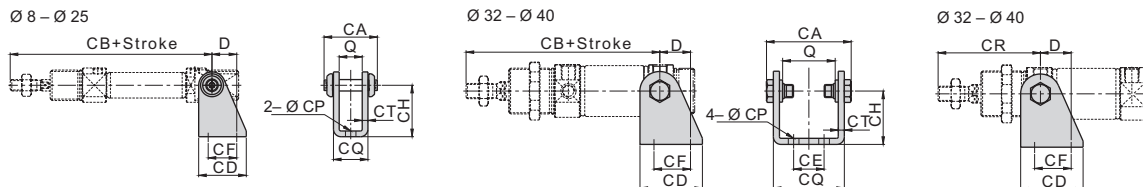

Dimensions and material

Type No.	Piston-Ø	D	Q	CA	CB	CD	CE	CF	CH	CP	CQ	CT	CR	Material
437.250	8	11	8.1	18.4	76	20	-	12.5	24	4.5	13.1	2.5	-	Steel
	10	11	8.1	18.4	76	20	-	12.5	24	4.5	13.1	2.5	-	
437.251	12	13	12.1	28	91	25	-	15	27	5.5	18.1	3	-	
	16	13	12.1	28	98	25	-	15	27	5.5	18.1	3	-	
437.252	20	16	16.1	38	115	32	-	20	30	6.6	24.1	4	-	
	25	16	16.1	38	126	32	-	20	30	6.6	24.1	4	-	
437.253	32	20	34.6	55.6	117	41	20	24	35	7	46.6	4	67	
437.254	40	27	42.6	69.6	146	52	28	30	40	9	58.6	5	81	

(Values in mm)

Foot model, »LB« type
437.200–437.204

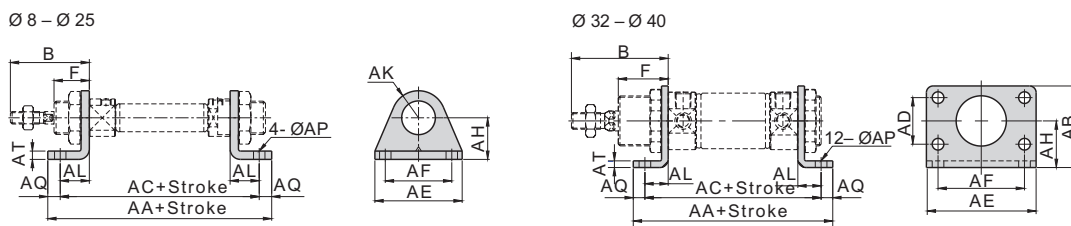

Dimensions and material

Type No.	Piston-Ø	B	F	AA	AB	AC	AD	AE	AF	AH	AK	AL	AP	AQ	AT	Material
437.200	8	28	12	78	-	68	-	35	25	16	10	11	4.5	5	3	Steel
	10	28	12	78	-	68	-	35	25	16	10	11	4.5	5	3	
437.201	12	38	17	90	-	78	-	42	32	20	13	14	5.5	6	4	
	16	38	17	96	-	84	-	42	32	20	13	14	5.5	6	4	
437.202	20	44	20	112	-	96	-	54	40	25	20	17	6.6	8	5	
	25	50	22	115	-	99	-	54	40	25	20	17	6.6	8	5	
437.203	32	58	30	110	49	96	28	66	52	28	-	14	7	7	4	
437.204	40	69	35	149	58	129	30	80	60	33	-	20	9	10	5	

(Values in mm)

Accessories

Rod eye model, »UNIT« type 437.320–437.221

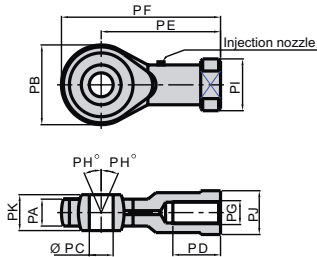

Dimensions and material

Type No.	Piston-Ø	PA	PB	PC(H9)	PD	PE	PF	PG	PH	PI	PJ	PK	Material
437.320	8–10	6	18	4	10	27	36	M4x0.7	13	12.5	10	8	Steel
437.321	12–16	6.8	20	6	12	30	40	M6x1.0	13	13	11	9	
437.322	20	9	24	8	16	36	48	M8x1.25	13	16	14	12	
437.220	25–32	11	26	10	20	43	56	M10x1.25	13	19	17	14	
437.221	40	12	32	12	22	50	66	M12x1.25	13	22	19	16	

(Values in mm)

Fork model, »Y« type 437.310–437.313, 437.211

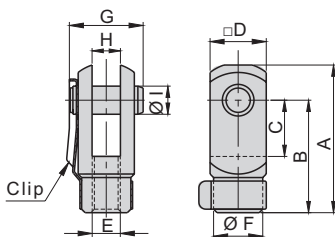

Dimensions and material

Type No.	Piston-Ø	A	B	C	D	E	F	G	H	I	Material
437.310	8–10	22	16	8	8	M4x0.7	7	11.5	4	4	Steel
437.311	12–16	32	24	12	12	M6x1.0	10	16	6	6	
437.312	20	42	32	16	16	M8x1.25	14	21	8	8	
437.313	25-32	52	40	20	19	M10x1.25	18	25	10	10	
437.211	40	62	48	24	25.4	M12x1.25	26.2	32.4	12	12	

(Values in mm)

Accessories

Sensors, »CS1« type 235.300–235.357

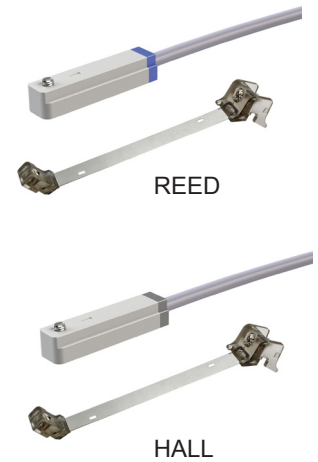
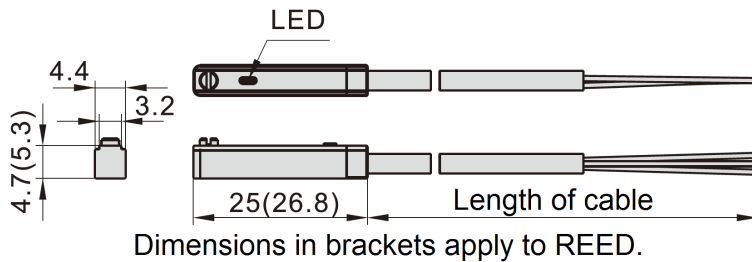

Specifications

	REED, NO	HALL, NO, NPN	HALL, NO, PNP
Operating voltage	5...240 V AC/DC	5...30 V DC	
Max. switching current	100 mA	30 V / 200 mA	
Max. switching rating	10 W	6 W	
Max. current consumption	-	5 mA	
Max. voltage drop	2.5 V at 100 mA DC	0.7 V	
Max. leakage current	-	0.01 mA	
Max. frequency	200 Hz	1000 Hz	
Shock resistance	50 g		
Protection circuit	-	reverse polarity protected, overvoltage protection	
Temperature range	-10 °C to 70 °C*		-10 °C to 70 °C
Enclosure classification	IP 64		IP 64**

* High temperature version (max. 125 °C) available on request.

** IP 68 available on request; only for versions with open cable.

Ordering information

Art. No.	Type No.	Description
115539 to 115546	235.300 to 235.307	Reed sensor, 2-wire, with M8 plug, with 150 mm cable length, NO
115547 to 115554	235.310 to 235.317	Reed sensor, 2-wire, with 3 m cable length, NO
115555 to 115562	235.320 to 235.327	Hall sensor, 3-wire, with M8 plug, with 150 mm cable length, NO, NPN
115563 to 115570	235.330 to 235.337	Hall sensor, 3-wire, with 3 m cable length, NO, NPN
115571 to 115578	235.340 to 235.347	Hall sensor, 3-wire, with M8 plug, with 150 mm cable length, NO, PNP
115579 to 115586	235.350 to 235.357	Hall sensor, 3-wire, with 3 m cable length, NO, PNP
118560	235.08SH	Sensor holder for round cylinder, piston \varnothing 8, for sensor type CS1, stainless steel
118561	235.10SH	Sensor holder for round cylinder, piston \varnothing 10, for sensor type CS1, stainless steel
118562	235.12SH	Sensor holder for round cylinder, piston \varnothing 12, for sensor type CS1, stainless steel
118563	235.16SH	Sensor holder for round cylinder, piston \varnothing 16, for sensor type CS1, stainless steel
118564	235.20SH	Sensor holder for round cylinder, piston \varnothing 20, for sensor type CS1, stainless steel
118565	235.25SH	Sensor holder for round cylinder, piston \varnothing 25, for sensor type CS1, stainless steel
118566	235.32SH	Sensor holder for round cylinder, piston \varnothing 32, for sensor type CS1, stainless steel
118567	235.40SH	Sensor holder for round cylinder, piston \varnothing 40, for sensor type CS1, stainless steel

*Art. No. 115539 (Type No. 235.300) to Art. No. 115546 (Type No. 235.307) are discontinued articles. Available while stocks last. Replacement Art. No. 116945 (Type No. 235.300-1) to Art. No. 116952 (Type No. 235.307-1). These can be found on the following page.

PIN assignment

M8 plug (2-wire sensor)

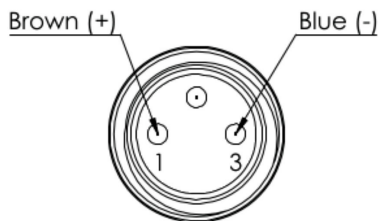

M8 plug (3-wire sensor)

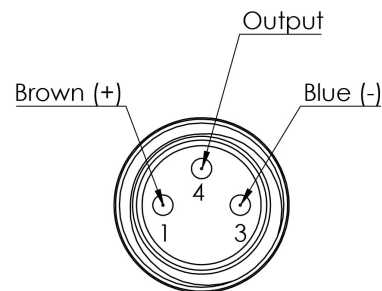

Dimensions plug

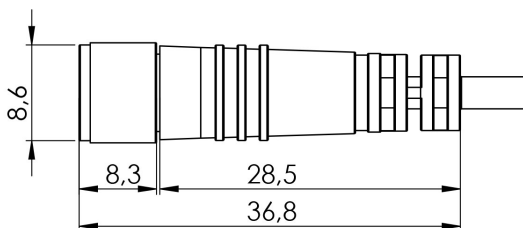

Ordering information

Art. No.	Type No.	Description
116945	235.300-1	REED, 2-wire, M8 plug, piston-Ø 8, with 150 mm cable length, NO, incl. holder,
116946	235.301-1	REED, 2-wire, M8 plug, piston-Ø 10, with 150 mm cable length, NO, incl. holder
116947	235.302-1	REED, 2-wire, M8 plug, piston-Ø 12, with 150 mm cable length, NO, incl. holder
116948	235.303-1	REED, 2-wire, M8 plug, piston-Ø 16, with 150 mm cable length, NO, incl. holder
116949	235.304-1	REED, 2-wire, M8 plug, piston-Ø 20, with 150 mm cable length, NO, incl. holder
116950	235.305-1	REED, 2-wire, M8 plug, piston-Ø 25, with 150 mm cable length, NO, incl. holder
116951	235.306-1	REED, 2-wire, M8 plug, piston-Ø 32, with 150 mm cable length, NO, incl. holder
116952	235.307-1	REED, 2-wire, M8 plug, piston-Ø 40, with 150 mm cable length, NO, incl. holder

PIN assignment

M8 plug (2-wire sensor)

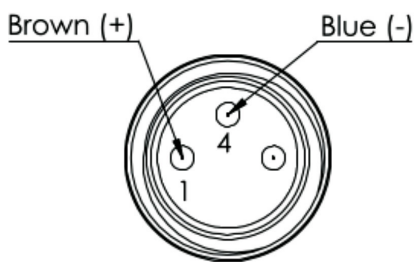

Dimensions plug

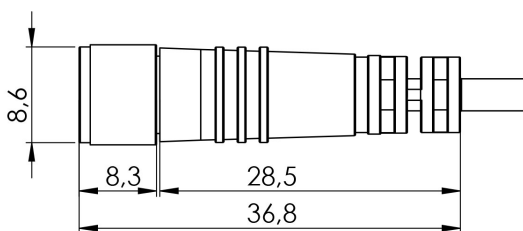

Accessories

Mounting

For mounting the sensor switch you have to carry out the following steps:

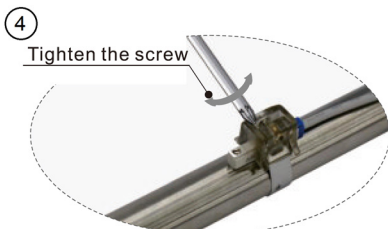
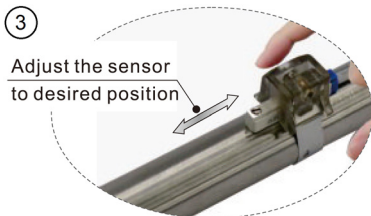
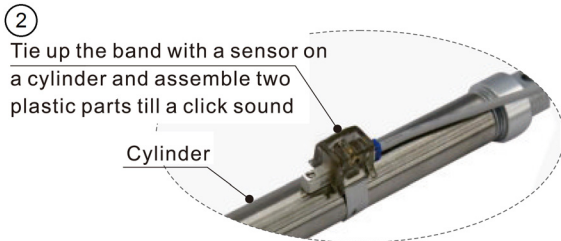
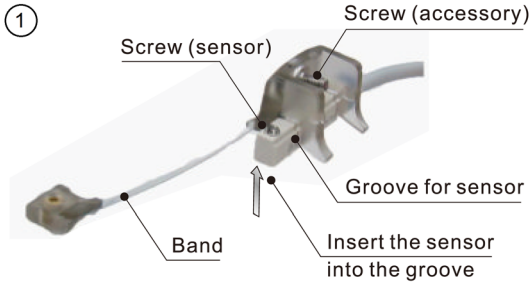

Ordering information

Type No.	Art. No.
11.DM.08010	114771
11.DM.08015	114772
11.DM.08020	114773
11.DM.08025	114774
11.DM.08030	114775
11.DM.08040	114776
11.DM.08050	114777
11.DM.08060	114778
11.DM.08075	114779
11.DM.08080	114780
11.DM.08100	114781
11.DM.08125	114782
11.DM.08150	114783
11.DM.10010	114784
11.DM.10015	114785
11.DM.10020	114786
11.DM.10025	114787
11.DM.10030	114788
11.DM.10040	114789
11.DM.10050	114790
11.DM.10060	114791
11.DM.10075	114792
11.DM.10080	114793
11.DM.10100	114794
11.DM.10125	114795
11.DM.10150	114796
11.DM.10160	114797
11.DM.10175	114798
11.DM.10200	114799
11.DM.12010	114800
11.DM.12015	114801
11.DM.12020	114802
11.DM.12025	114803
11.DM.12030	114804
11.DM.12040	114805
11.DM.12050	114806
11.DM.12060	114807
11.DM.12075	114808
11.DM.12080	114809
11.DM.12100	114810
11.DM.12125	114811
11.DM.12150	114812
11.DM.12160	114813
11.DM.12175	114814
11.DM.12200	114815
11.DM.12250	114816

Ordering information

Type No.	Art. No.
11.DM.16010	114817
11.DM.16015	114818
11.DM.16020	114819
11.DM.16025	114820
11.DM.16030	114821
11.DM.16040	114822
11.DM.16050	114823
11.DM.16060	114824
11.DM.16075	114825
11.DM.16080	114826
11.DM.16100	114827
11.DM.16125	114828
11.DM.16150	114829
11.DM.16160	114830
11.DM.16175	114831
11.DM.16200	114832
11.DM.16250	114833
11.DM.16300	114834
11.DM.20010	114835
11.DM.20015	114836
11.DM.20020	114837
11.DM.20025	114838
11.DM.20030	114839
11.DM.20040	114840
11.DM.20050	114841
11.DM.20060	114842
11.DM.20075	114843
11.DM.20080	114844
11.DM.20100	114845
11.DM.20125	114846
11.DM.20150	114847
11.DM.20160	114848
11.DM.20175	114849
11.DM.20200	114850
11.DM.20250	114851
11.DM.20300	114852
11.DM.20350	114853
11.DM.20400	114854
11.DM.20450	114855
11.DM.20500	114856
11.DM.20600	114857
11.DM.25010	114858
11.DM.25015	114859
11.DM.25020	114860
11.DM.25025	114861
11.DM.25030	114862
11.DM.25040	114863
11.DM.25050	114884
11.DM.25060	114865
11.DM.25075	114866
11.DM.25080	114867
11.DM.25100	114868
11.DM.25125	114869

Ordering information

Type No.	Art. No.
11.DM.25150	114870
11.DM.25160	114871
11.DM.25175	114872
11.DM.25200	114873
11.DM.25250	114874
11.DM.25300	114875
11.DM.25350	114876
11.DM.25400	114877
11.DM.25450	114878
11.DM.25500	114879
11.DM.25600	114880
11.DM.32010	114881
11.DM.32015	114882
11.DM.32020	114883
11.DM.32025	114884
11.DM.32030	114885
11.DM.32040	114886
11.DM.32050	114887
11.DM.32060	114888
11.DM.32075	114889
11.DM.32080	114890
11.DM.32100	114891
11.DM.32125	114892
11.DM.32150	114893
11.DM.32160	114894
11.DM.32175	114895
11.DM.32200	114896
11.DM.32250	114897
11.DM.32300	114898
11.DM.32350	114899
11.DM.32400	114900
11.DM.32450	114901
11.DM.32500	114902
11.DM.32600	114903
11.DM.40010	114904
11.DM.40015	114905
11.DM.40020	114906
11.DM.40025	114907
11.DM.40030	114908
11.DM.40040	114909
11.DM.40050	114910
11.DM.40060	114911
11.DM.40075	114912
11.DM.40080	114913
11.DM.40100	114914
11.DM.10125	114915
11.DM.40150	114916
11.DM.40160	114917
11.DM.40175	114918
11.DM.40200	114919
11.DM.40250	114920
11.DM.40300	114921
11.DM.40350	114922

Ordering information

Type No.	Art. No.
11.DM.40400	114923
11.DM.40450	114924
11.DM.40500	114925
11.DM.40600	114926
11.EM.08010	114927
11.EM.08015	114928
11.EM.08020	114929
11.EM.08025	114930
11.EM.08030	114931
11.EM.08040	114932
11.EM.08050	114933
11.EM.10010	114934
11.EM.10015	114935
11.EM.10020	114936
11.EM.10025	114937
11.EM.10030	114938
11.EM.10040	114939
11.EM.10050	114940
11.EM.12010	114941
11.EM.12015	114942
11.EM.12020	114943
11.EM.12025	114944
11.EM.12030	114945
11.EM.12040	114946
11.EM.12050	114947
11.EM.16010	114948
11.EM.16015	114949
11.EM.16020	114950
11.EM.16025	114951
11.EM.16030	114952
11.EM.16040	114953
11.EM.16050	114954
11.EM.16060	114955
11.EM.16075	114956
11.EM.16080	114957
11.EM.16100	114958
11.EM.20010	114959
11.EM.20015	114960
11.EM.20020	114961
11.EM.20025	114962
11.EM.20030	114963
11.EM.20040	114964
11.EM.20050	114965
11.EM.20060	114966
11.EM.20075	114967
11.EM.20080	114968
11.EM.20100	114969
11.EM.20125	114970
11.EM.20150	114971

Ordering information

Type No.	Art. No.
11.EM.25010	114972
11.EM.25015	114973
11.EM.25020	114974
11.EM.25025	114975
11.EM.25030	114976
11.EM.25040	114977
11.EM.25050	114978
11.EM.25060	114979
11.EM.25075	114980
11.EM.25080	114981
11.EM.25100	114982
11.EM.25125	114983
11.EM.25150	114984
11.EM.32010	114985
11.EM.32015	114986
11.EM.32020	114987
11.EM.32025	114988
11.EM.32030	114989
11.EM.32040	114990
11.EM.32050	114991
11.EM.32060	114992
11.EM.32075	114993
11.EM.32080	114994
11.EM.32100	114995
11.EM.32125	114996
11.EM.32150	114997
11.EM.40010	114998
11.EM.40015	114999
11.EM.40020	115000
11.EM.40025	115001
11.EM.40030	115002
11.EM.40040	115003
11.EM.40050	115004
11.EM.40060	115005
11.EM.40075	115006
11.EM.40080	115007
11.EM.40100	115008
11.EM.40125	115009
11.EM.40150	115010

Ordering information

Type No.	Art. No.
437.200	115804
437.201	115805
437.202	115806
437.203	115807
437.204	115808
437.240	115824
437.241	115825
437.241-1	148900
437.242	115826
437.242-1	148902
437.250	115827
437.251	115828
437.252	115829
437.253	115830
437.254	115831
437.230	115819
437.231	115820
437.232	115821
437.233	115822
437.234	115823
437.310	115832
437.311	115833
437.312	115834
437.313	115835
437.211	115810
437.320	115836
437.321	115837
437.322	115838
437.220	115814
437.221	115815
235.300	115539
235.301	115540
235.302	115541
235.303	115542
235.304	115543
235.305	115544
235.306	115545
235.307	115546
235.310	115547
235.311	115548
235.312	115549
235.313	115550
235.314	115551
235.315	115552
235.316	115553
235.317	115554

Ordering information

Type No.	Art. No.
235.320	115555
235.321	115556
235.322	115557
235.323	115558
235.324	115559
235.325	115560
235.326	115561
235.327	115562
235.330	115563
235.331	115564
235.332	115565
235.333	115566
235.334	115567
235.335	115568
235.336	115569
235.337	115570
235.340	115571
235.341	115572
235.342	115573
235.343	115574
235.344	115575
235.345	115576
235.346	115577
235.347	115578
235.350	115579
235.351	115580
235.352	115581
235.353	115582
235.354	115583
235.355	115584
235.356	115585
235.357	115586
235.08SH	118560
235.10SH	118561
235.12SH	118562
235.16SH	118563
235.20SH	118564
235.25SH	118565
235.32SH	118566
235.40SH	118567